

URAL Motorcycles

Owner's Manual

2004 Model

Retro Solo



Irbit Motorworks of America Inc.

15411 NE 95th St

Redmond WA

98052

www.imz-ural.com

Contents

Introduction	5
Warnings, Cautions, Notes	5

Chapter 1 Specifications

Specifications	7
Torque Specifications	10
Conversions	10

Chapter 2 Motorcycle Controls & Instrumentation

Motorcycle Controls & Instrumentation	11
Controls	12
Control Cable Adjustment	16
Control Cable Maintenance	16
Speedometer	16

Chapter 3 Engine Operation

Engine Operation and Maintenance	17
Pre-Trip Preliminaries	17
Starting the Engine	17
Operating Precautions	21
Running-In the New Motorcycle	21

Chapter 4 Engine Design

Brief Description of Design & Maintenance	23
Lubrication System	24
Fuel System	25
Ignition System	26
Ignition Timing	26

Chapter 5 Carburetors

Carburetors	29
Carburetor Maintenance	30

Chapter 6 Power Transmission

Power Transmission	31
Clutch	31
Gearbox	31
Final Drive	31

Chapter 7 Running Gear

Running Gear	33
Spring-Loaded Hydraulic Shock Absorber	33
Front Fork	34
Steering Head Bearings	34

Chapter 8 Wheel & Tires

Wheels and Tires	35
Tire Data	36
Wheel and Tire Maintenance	37

Chapter 9 Brakes

Brakes	39
--------------	----

Chapter 10 Electrical

Electrical Equipment	43
Electrical Circuits.....	43
Electrical Equipment Maintenance	44
Electrical Wiring Diagram	46

Chapter 11 Maintenance

Maintenance of Motorcycle	47
List of Recommended Lubricants	47
Lubrication Chart	48
Required Lubrication	48
Care of Motorcycle Paint	48
Preservation and Storage	49
Battery	50
List of Individual Tool Set, Spare Parts, Accessories & Documents	51

Chapter 12 Safe Operating Rules

Safe Operating Rules	53
----------------------------	----

Chapter 13 Warranty

Warranty Agreement	55
Warranty Claim Form	63
Flat Rate Schedule	64

Chapter 14 Service Coupons

Service Coupons	67
New Address Form	77
New Owner Form	78
URAL Starting and Running Tips	Inside Back Cover

INTRODUCTION

Welcome to the URAL Motorcycling Family! Your Ural has been built by the Irbit Motorcycle Factory in Russia and distributed by Irbit Motorworks of America, the United States affiliate of the Irbit Motorcycle Factory. The Ural motorcycle conforms to all applicable US Federal Motor Vehicle Safety Standards and US Environmental Protection Agency regulations effective on the date of manufacture.

This manual has been prepared to acquaint you with the operation, care and maintenance of your motorcycle, and to provide you with important safety information. Follow these instructions carefully for maximum motorcycle performance and for your personal motorcycling safety and pleasure.

Your Owner's Manual contains instructions for operation, maintenance and minor repairs. Major repairs require the attention of a skilled mechanic and the use of special tools and equipment. Your Authorized IMWA Ural Dealer has the facilities, experience and genuine Ural parts necessary to provide this valuable service.

Any suggestions or comments are welcome! Write to us or post an e-mail on the Ural Discussion bulletin board at www.imz-ural.com.

Happy Riding!

Important Notice!

Statements in this manual preceded by the following words are of special importance:

WARNING: *MEANS THERE IS THE POSSIBILITY OF PERSONAL INJURY TO YOURSELF OR OTHERS.*

CAUTION: *Means there is the possibility of damage to the vehicle.*

NOTE: *Other information of particular importance has been placed in italic type.*

CAUTION! *During the initial 1,500 km, a fundamental bedding-in of parts for all the mechanisms of the motorcycle takes place. During this period do not race, overload, or lug the engine. Note the riding procedures described in the section "Running-In of New Motorcycle." Following those procedures will ensure that you have the most powerful & smoothly operating engine after break-in.*

Maintenance intervals recommended are based on operational experience under various climatic and road conditions. However, these intervals may be extended or reduced following repeated checks of the lubricant condition and general mechanical condition of the motorcycle.

Carefully study this Owner's Manual before starting the motorcycle.
Specifications and design are subject to change without notice.

Chapter 1

SPECIFICATIONS

GENERAL

	Retro
Maximum speed of motorcycle	120 km/h 74 mph
Reference fuel consumption at 85% of	14 km/L 33 mpg
Dry mass of motorcycle	680 lb.
Maximum load-carrying capacity	400 lb.
Noise level	below 80db

OVERALL DIMENSIONS

Length	2500 mm / 8 ft
Width	1700 mm / 5 ft 6 in
Height	1100 mm / 3 ft 6 in
Road Clearance	125 mm / 5 in
Seat height	840 mm / 33 in
Wheel base	1470 mm / 58 in

ENGINE

Type	4 stroke, overhead valves, opposed twin-cylinder
Displacement	745 cc
Cylinder bore	78 mm
Piston stroke	78 mm
Compression ratio	9.0 :1
Rated horsepower	33 KW / 44.2 BHp
Rated rotational speed	5600 RPM
Rated torque	36 ft.-lbs @ 3750 RPM
Lubrication system	Dual system of forced lubrication and splashing
Lubricant	SAE 20W/50

CARBURETOR

Carburetor type	32 CVK Keihin
Number of carburetors	2
Air cleaner	Paper Filter Element Lifetime JR
Fuel	91 octane premium unleaded gasoline
PCV Valve	Internal Breather

ELECTRICAL

Ignition system	135.3734.COM-2 (CDI)
Ignition coil	135.3705-2
Spark plugs	NGK BP7H
Ignition timing	Automatic spark timer
Alternator	35 amp / 12 Volt
Battery	Interstate #YB18L-A or equivalent
Headlight	Sylvania Halogen 6024, 7" round sealed beam

TRANSMISSION

Clutch	Dry double-disk clutch
Gearbox	4 speed gearbox with reverse gear lever

GEAR RATIOS

I gear	3.6
II gear	2.28
III gear	1.56
IV gear	1.19
Reverse gear	4.36
Speedometer drive ratio	0.4
Final drive ratio	3.86

FLUID CAPACITIES

Fuel tank	5 Gal / 19L
Reserve	.5 Gal / 2L
Engine	68 oz / 2L
Transmission	30.6 oz / .9 L
Final drive	3.74 oz / 110 ml
Shock Absorbers	3.5 oz / 105 ml

RUNNING GEAR

Frame Tubular welded	
Rear wheel suspension	Swing arms with spring shock absorbers
Front fork	Telescopic
Brakes	Hydraulic Disk on front, Hydraulic Drum on rear
Tires	110/90 - 18"
	Front 22 psi cold (1.5 Bar / 150 kPa) Front 22 psi cold
	Rear 36 psi cold (2.5 Bar / 250 kPa) Rear 36 psi cold

CLEARANCES

	mm	in
Valves with engine cold	0.15 to 0.1	0.006 to 0.004
Between spark plug electrodes	1.016	0.040
Backlash between tooth faces of bevel gears in final drive	0.1 - 0.3	0.001

FREE TRAVEL / ADJUSTMENTS

	mm	in
Hand brake control lever	5 - 8	0.2 - 0.3
Clutch control lever	5 - 8	0.2 - 0.3
Foot brake drive pedal	¼ of full stroke of pedal, 25 - 30	1.0 - 1.2

TORQUE SPECIFICATIONS

Metric	US Equivalent	Location on Bike
54 to 61 Nm	40 ft/lb to 45 ft/lb	cylinder heads
237 to 251 Nm	175 ft/lb to 185 ft/lb	fly wheel tightening screws
19 to 30 Nm top	14 ft/lb to 22 ft/lb	shock absorber
38 to 49 Nm bottom	28 ft/lb to 36 ft/lb	shock absorber
30 to 35 Nm	22 ft/lb to 26 ft/lb	bearing nut
30 to 35 Nm	22 ft/lb to 26 ft/lb	final drive to swing arm bolts
8 to 10 Nm	5.8 ft/lb to 7.2 ft/lb	oil pump bolt
8 to 10 Nm	5.8 ft/lb to 7.2 ft/lb	engine sump
14 to 19 Nm	10 ft/lb to 14 ft/lb	final drive case nuts
68 to 90 Nm	50 ft/lb to 66 ft/lb	nut fastening the pinion bearing
22 to 27 Nm	16 ft/lb to 20 ft/lb	reverse gear brake lever
19 to 22 Nm	14 ft/lb to 16 ft/lb	alternator gear nut
136 to 163 Nm	100 ft/lb to 120 ft/lb	steering stem nut

CONVERSIONS

To convert from mm to in, divide by 25.4 (there are 25.4 mm per inch).

To convert from liters to gallons, divide by 3.785 (there are 3.78 liters per gallon).

To convert from liters to quarts, multiply by 1.056 (there are 1.056 quarts per liter).

To convert from liters to pints, multiply by 2.112 (there are 2.112 pints per liter).

To convert from km to miles, multiply by .62 (there is .62 mile per km).

To convert from km/hr to mph, multiply by .62.

To convert from Newton-meter (Nm) to inch-pound, multiply by 8.86.

To convert from Newton-meter (Nm) to foot-pound, multiply by .7376.

To convert from cm^3 (cc) to pints, divide by 473 (there are 473 cc per pint).

To convert Celcius to Fahrenheit: $F^\circ = C^\circ \times 1.8 + 32$.

To convert Fahrenheit to Celcius, $C^\circ = (F^\circ - 32) \text{ divide by } 1.8$.

Chapter 2

MOTORCYCLE CONTROLS & INSTRUMENTATION

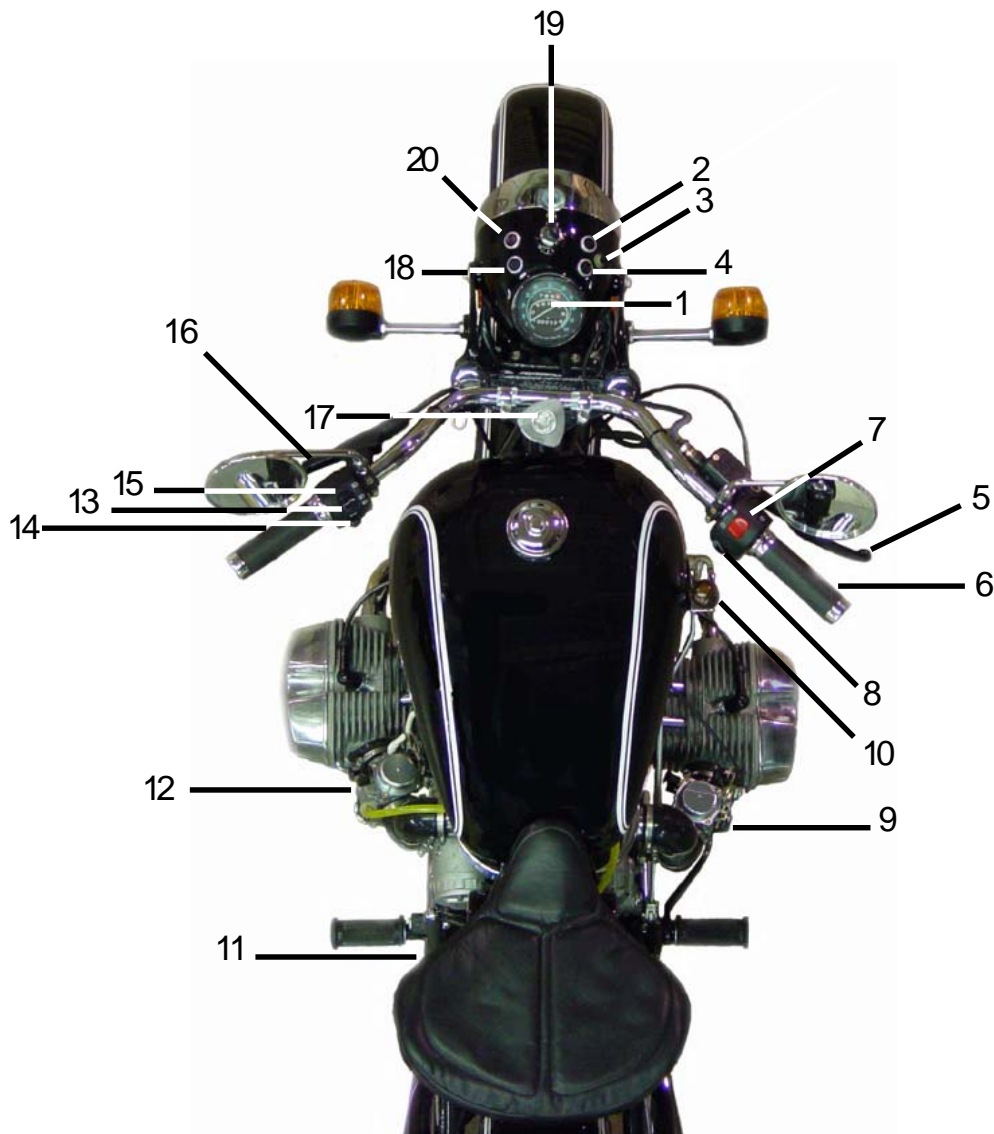

Controls and Instrumentation

- 1 - Speedometer
- 2 - Turn indicator lamp
- 3 - Trip odometer reset knob
- 4 - Neutral and reverse gear engagement indicator lamp
- 5 - Front brake control lever
- 6 - Throttle control twist grip
- 7 - Ignition cutoff switch
- 8 - Electric Start Button
- 9 - Rear brake pedal & sidecar wheel brake
- 10 - Reverse gear lever
- 11 - Kick start lever
- 12 - Gear shift (foot) pedal
- 13 - Turn signal switch
- 14 - Horn push-button
- 15 - "High-low" beam switch
- 16 - Clutch control lever
- 17 - Steering damper tightening bolt
- 18 - High-beam indicator lamp
- 19 - Ignition Switch
- 20 - Battery discharge warning lamp



Clutch Control Lever



Front Brake Control Lever

Clutch control lever When the clutch lever is squeezed, the engine is disengaged from the gearbox. When the lever is released, the engine and gearbox are connected.

WARNING: *MAKE SURE FINGERS ARE NOT POSITIONED BETWEEN HAND CONTROL LEVERS AND HANDLEBAR GRIPS OR OPERATION OF VEHICLE COULD BE IMPAIRED.*

WARNING: *BEFORE STARTING ENGINE, ALWAYS SHIFT TRANSMISSION TO NEUTRAL TO PREVENT ACCIDENTAL MOVEMENT WHICH COULD CAUSE POSSIBLE DAMAGE TO MOTORCYCLE AND PERSONAL INJURY.*

Caution: *Always engage the clutch release lever when shifting. Serious internal damage may result to the transmission if the clutch release lever is not engaged.*

Front brake control lever When the lever is squeezed, the front wheel brake is actuated. The front brake should be used together with rear brake. When the brake lever is squeezed, the stop signal lights are switched on.

REAR BRAKE PEDAL IS USED TO ACTUATE THE REAR BRAKES.

Kick starter is designed to start the engine. On pressing the lever, the crankshaft of the engine is rotated via the gearbox. The lever is returned to its initial position by a spring inside the gearbox.

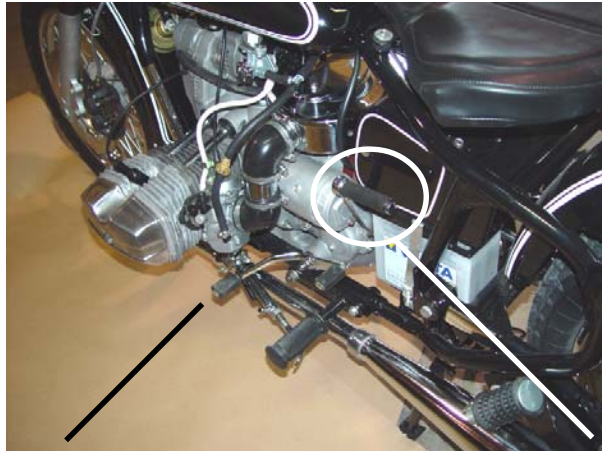

Gear shift lever

Kick Starter



Reverse Gear Selector

Gear shift Lever. When the front pedal is pressed, shifting from higher to lower gear takes place. When the rear pedal is pressed, shifting from lower to higher gear takes place. The neutral position is fixed between the 1st and 2nd gears. It is important to shift smoothly with a constant force and not to kick the gear shift pedal.

Reverse gear is engaged by pushing forward on the reverse gear selector. Reverse gear should only be engaged from neutral or 1st gear, after the motorcycle has come to a complete stop. When the reverse gear selector is pulled backward, the transmission will be in neutral.

IMPORTANT! The green pilot lamp will illuminate when the transmission is in neutral or reverse gear. (see “Starting the Engine”).

WARNING: DO NOT LET YOUR FOOT REST ON THE EXHAUST HEADER PIPE. SERIOUS INJURY OR BURNS MAY RESULT.

WARNING: DO NOT APPLY EITHER BRAKE STRONGLY ENOUGH TO LOCK THE WHEELS BECAUSE THIS MAY

CAUSE POSSIBLE LOSS OF CONTROL OF THE MOTORCYCLE. ALWAYS USE BOTH BRAKES. NEVER STOP WITH FRONT OR REAR BRAKE ONLY.

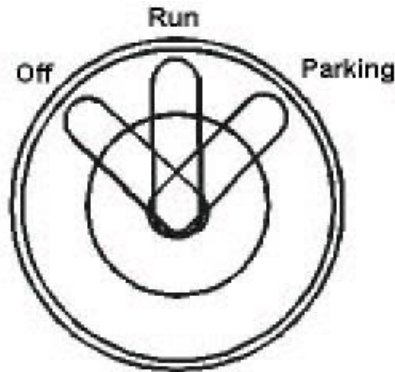

Ignition Switch has three fixed positions of the key.
The positions of the ignition are shown above.

- | | |
|---------|--|
| Off | All electrical systems are off. |
| Run | Voltage is supplied to all electrical systems. |
| Parking | Voltage is supplied to running lights only. |

Note: Leaving the key in the Run or Parking position will discharge the battery. Always return the key to the Off position before removing it.

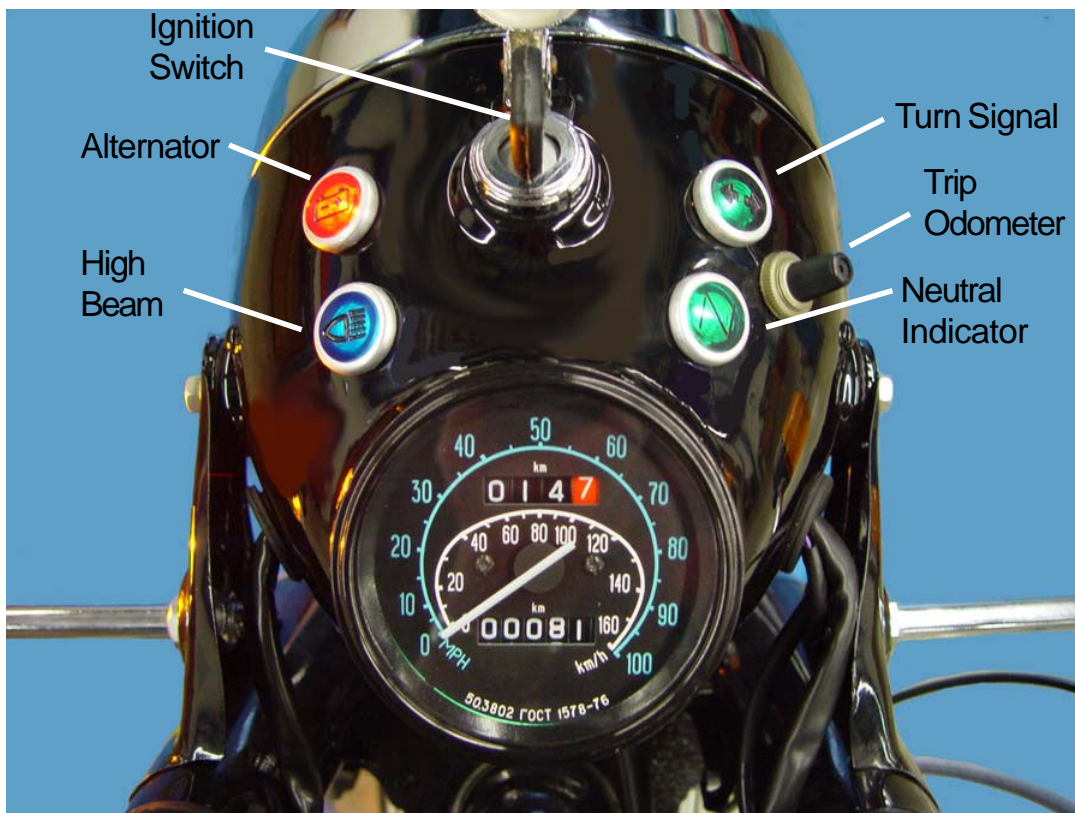

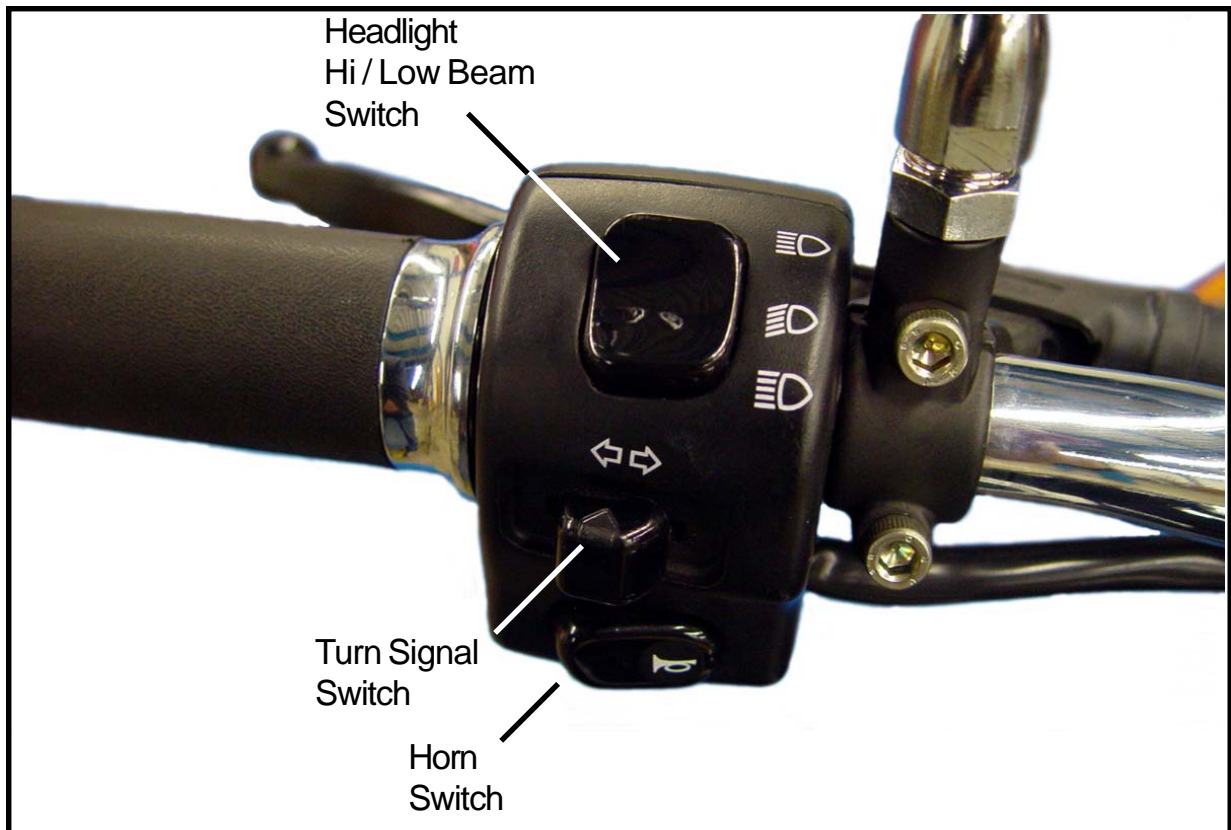
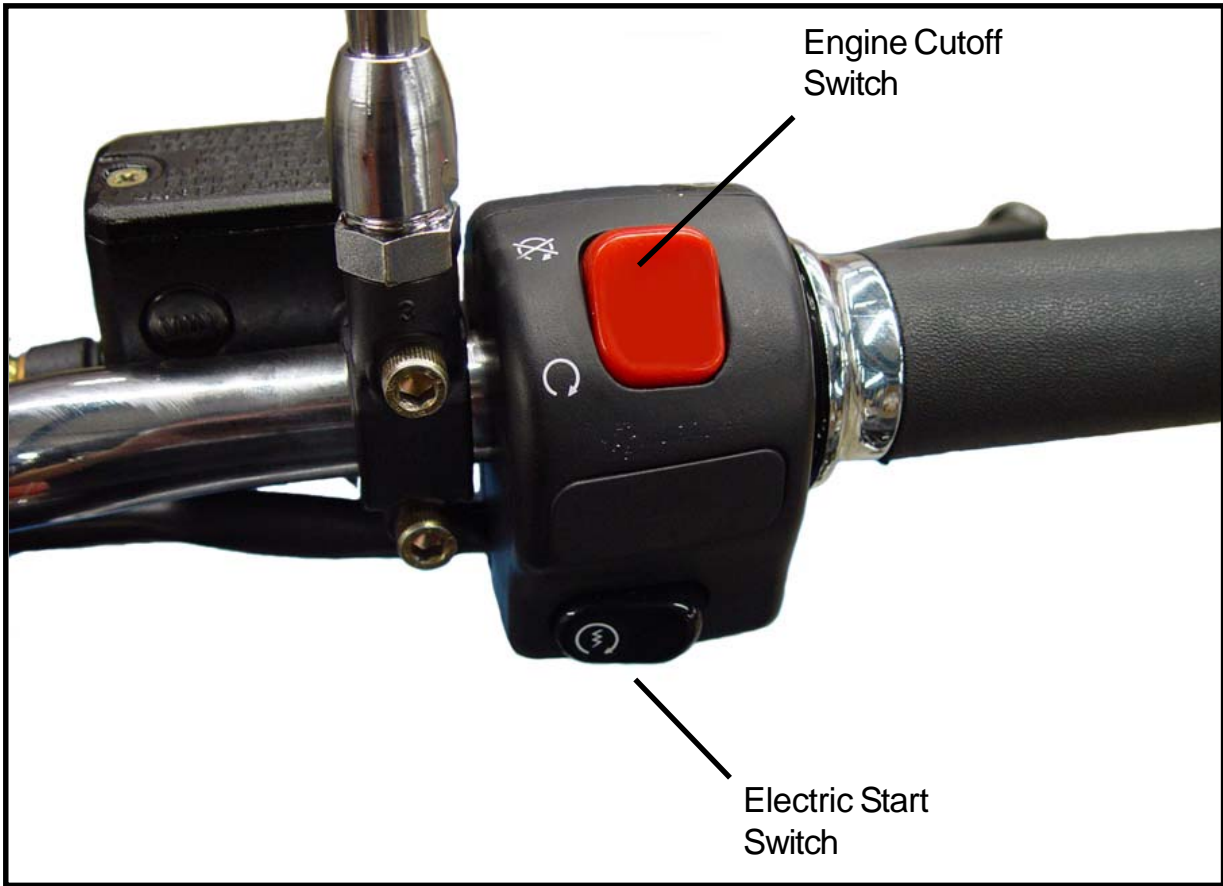

CONTROL CABLE ADJUSTMENT

The control cables are adjusted by screw adjustments at the cable ends.

With the control levers released:

- for the clutch a play at the clutch lever end should be equal to 5 - 8 mm/0.2 - 0.3 in.
- for the carburetors - carburetor throttle cables synchronized

With the control levers (handles) fully depressed:

- for the clutch — complete disengagement of the engine from the transmission; noiseless shifting of gears means good adjustment of the clutch cable.
- for the carburetors — lift of throttles to the maximum and equal height

CONTROL CABLE MAINTENANCE

The daily preventative maintenance involves checking the functioning, condition and fastening of the tie rods, cables and braking action. Refer to the Service Coupons for lubrication schedule.

As per the service coupons, lubricate the throttle control twist grip, the lever pins and ends of cables used in the clutch and the throttles.



SPEEDOMETER MAINTENANCE

After every 10,000 km, remove the speedometer from the motorcycle and add five or six drops of oil into the speedometer where the cable inserts into the speedometer. This will lubricate the speedometer internally.

To lubricate the speedometer cable, remove the cable from the speedometer and pull straight. Use speedometer lubricating oil or light machine oil.

Chapter 3

ENGINE OPERATION

PRE-TRIP PRELIMINARIES

Pre-Trip Check List

1. Check all lights and the horn for proper operation.
2. Check the brake and clutch levers and/or pedals.
3. Make sure all wheels and the final drive assemblies are securely fastened .
4. Check the carburetor flanges and air filter ducts for integrity and proper alignment.
5. Check the tire tread depth - should be greater than 1/8 inch.

Gasoline level in the fully filled tank should be 10 - 15 mm / $\frac{1}{2}$ - $\frac{3}{4}$ in. below the lower edge of the tank filler. Do not overfill the tank.

See that the oil level in the engine crankcase is not higher than the top and not lower than the bottom marks on the dipstick with the filler plug undone. (See chapter 4 Lubrication System)

CAUTION: *When checking the engine oil level, be careful that dirt and debris do not contaminate the oil.*

STARTING THE ENGINE

WARNING: *BEFORE STARTING THE ENGINE, MAKE SURE THAT THE GEAR SHIFT MECHANISM IS IN THE NEUTRAL POSITION (BETWEEN 1ST AND 2ND GEARS) TO PREVENT ACCIDENTAL MOVEMENT WHICH COULD CAUSE POSSIBLE DAMAGE TO MOTORCYCLE AND PERSONAL INJURY. (FOR MORE THAN JUST STARTING, I.E. IDLING, IT IS ADVISABLE TO USE NEUTRAL GEAR.)*

When the ignition is switched on, the green & red lamps on the instrument panel should illuminate. This will indicate that the battery is discharging while the engine is not running and that the motorcycle is in neutral.



Prime Position



Fuel On
Position



Reserve Fuel
Position

1. When starting the engine after the motorcycle has been parked for an extended period of time, or after the fuel tank and/or carburetors have been completely emptied of gasoline (e.g. due to running out of fuel, evaporation, or installation of replacement parts), set the valve to the "PRI" (Prime) position. This would allow gasoline to fill the float chambers of the carburetors and prepare the engine for starting.
2. Start the engine
3. After the engine starts, set the valve to the "ON" position and keep the valve in this position for regular use of the motorcycle. (When set to "ON", the valve is automatically activated when the engine starts and stops, opening and shutting off the supply of fuel to the carburetors)
4. After using up the main volume of fuel (engine starts stalling due to lack of fuel), set the valve to the "RES" (Reserve) position and continue driving. After refueling, remember to set the valve back to "ON" to avoid running out of fuel completely.

IMPORTANT: *When parking the motorcycle for extended periods of time, the valve should remain in the "ON" position.*

WARNING: *Never leave the motorcycle with the engine turned off and the valve set to "PRI" as this may result in a serious damage to the engine and will void your warranty.*

The carburetor enrichers provide extra fuel to the mixture. This extra fuel will allow a cold engine to start and run until it has warmed up sufficiently to allow normal operation. Use caution when using the enrichers, as they can easily cause the engine to flood, or foul the spark plugs. The enrichers should only be left on as long as necessary to keep the engine running while cold and should be turned off as soon as possible.

Depending on the engine and ambient temperature, use the carburetor enrichers and starting procedure as follows:



Enrichener off



Enrichener on

Manual Starting (without electric starter)

1. Turn on the ignition and depress the kick lever about 1/4 of its travel (enough to firmly get the ball of your foot on the lever) with either your left foot or right foot, depending on what position is most comfortable with your right hand on the throttle. Take up the slack in the throttle until you can feel some slight resistance from the return springs in the carburetors, without any advance on the throttle, since this may flood the engine.
2. Give the kick lever a swift kick. When the engine starts, tickle the throttle (quickly increase and decrease it) to keep the engine running, but not too fast. If the engine doesn't start, repeat the kicking procedure. A properly adjusted warm engine should start within a few kicks. If the engine doesn't start, try the procedure described below in item
3. If it still doesn't start or fire, it may be flooded.

Note: Do not completely open the throttle while kicking the engine over since it may flood the engine and the spark plugs may become fouled with gasoline.

Electric Starting

1. Set carburetor enricheners as with kick starting. Unlike manual starting, however, the gearbox does not have to be in neutral as the electric starter may be engaged with the clutch lever pulled in, or with the gearbox in neutral. Make sure the Ignition Cutoff Switch is set to "Ignition On" and push the starter button to turn over the engine.
2. When the engine has been standing for several hours but the ambient temperature is high (60°F/15°C degrees or above), try starting it without any enricheners. If it doesn't fire, then use the procedure described below.

3. When the engine is cool or cold and the ambient temperature is between 40°F-60°F/5°C-15°C, engage both enrichers to start. As soon as the engine starts, immediately retract the enrichers. Run the engine at moderate speed for 30-60 seconds. If it starts to die, blip the twist grip throttle (rapidly twist part way towards full throttle and then back off) to keep the engine running. After 1 to 3 minutes, depending on ambient temperature, the engine should run smoothly without “blipping” the throttle.

4. If the engine is cold and ambient temperature is below 40°F, first, give the engine 5-10 (depending on how cold it is) priming kicks with the ignition off. This will get some oil circulated to key internal parts. Engage the enrichers on both carburetors. The engine should then fire, depending on how cold it is. For example, when the ambient temperature is 0°F, it typically takes about 5-10 rotations to start the engine. As soon as the engine starts, retract both enrichers (after a few seconds).

Note: It is very important to back off on the enrichers as soon as the engine will sustain itself without stalling. Since the Ural is a carbureted air cooled engine, the plugs will foul quickly (as soon as one minute) if the engine mixture is too rich. If one plug fouls and the other doesn't, the engine will run unevenly and may cause internal damage.

When the engine is hot, do not choke or enrichen the carburetors. To do so risks flooding the engine.

To start an engine that is flooded, first open the throttle fully, hold it there and give the engine up to 10 swift kicks. If it still doesn't fire, take the spark plugs out to see if they are wet with gasoline. If they are wet, dry them. Clear excess gasoline from the cylinders by kicking the engine over 10 times with the plugs out and the throttle closed. Then replace the plugs and repeat the starting procedure described at the beginning of this section (1).

WARNING: SUSTAINED OPERATION ON ONLY ONE CYLINDER FOR EVEN JUST A FEW MINUTES COULD OVERHEAT THE CYLINDER AND CAUSE IRREVERSIBLE DAMAGE TO EITHER THE VALVES OR PISTON. *THIS IS CRITICAL TO IMMEDIATELY SHUT THE ENGINE DOWN IF IT APPEARS TO BE RUNNING ON ONLY ONE CYLINDER.*

Additional Warnings: Once the engine starts, do not allow it to run at a high speed as this could cause abnormal wear of the parts and may lead to seizure of the piston pin and pistons in the cylinders since cold oil flows through the oil ducts with difficulty and fails to ensure sufficient lubrication. A correctly adjusted warm engine should run steadily at low speed with the throttle control

twist grip fully closed.

Do not let the motorcycle sit at idle for more than three minutes, as overheating could result.

OPERATING PRECAUTIONS

WARNING: *MAKE SURE THAT SIDECAR WINDSHIELD IS IN THE FULL BACK POSITION SO IT DOESN'T INTERFERE WITH THE RIGHT HANDLEBAR.*

To move the motorcycle from rest, shift to 1st gear only. Avoid releasing the clutch suddenly, because the engine is liable to stall or the motorcycle will start with a jerk. Do not drive the motorcycle at speeds below the recommended speeds with the 2nd, 3rd or 4th gears engaged. It is not advisable to use the 1st and 2nd gears for a long time, unless so required by road conditions.

RUNNING IN THE NEW MOTORCYCLE

The running-in period for the motorcycle is the first 1,500 km.

There are no special procedures that must be followed, but during the running-in period, a new motorcycle requires the most careful attention. In the course of this period, do not overload the machine. Avoid traveling on freeways and climbing steep hills. Do not race the engine or overheat it at any time. Vary the throttle setting frequently, so as to avoid constant RPMs. Allow the new engine frequent rest periods for cooling down.

WARNING: *SHIFTING TO LOWER GEARS WHEN SPEED IS TOO HIGH MAY SEVERELY DAMAGE THE TRANSMISSION OR CAUSE THE REAR WHEEL TO LOSE TRACTION.*

CAUTION: *Do not run the engine at extremely high rpms with clutch disengaged or transmission in neutral. Do not idle the engine unnecessarily for more than a few minutes with the motorcycle standing still.*

When operating the Ural motorcycle on the highway, please try not to run continuously at speeds above 65mph. If it is necessary to drive at speeds of 65mph and above let the engine cool by running at a reduced speed for 10 - 15 minutes every 30 minutes if possible, this will provide longer engine life.

WARNING: *WHEN RIDING ON WET ROADS OR UNDER RAINY CONDITIONS, BRAKING EFFICIENCY IS GREATLY REDUCED AND CAUTION SHOULD BE USED WHEN APPLYING THE BRAKES, ACCELERATING OR TURNING. THIS IS ESPECIALLY TRUE IMMEDIATELY AFTER THE RAIN BEGINS AND THE OIL FROM THE ROAD SURFACE COMBINES WITH THE WATER.*

When descending a long, steep grade, downshift and use engine compression together with intermittent application of both brakes to slow the motorcycle. Avoid continuous use of brakes to reduce overheating of the brakes and reduced efficiency.

While using the motorcycle in summer, pay special attention to the condition of the tires. Keep them inflated up to pressures specified in this manual.

Chapter 4

ENGINE DESIGN

The motorcycle is equipped with a two-cylinder four-stroke air-cooled engine. The opposed arrangement of cylinders in the horizontal plane is the outstanding feature of the motorcycle design which ensures proper cooling and balancing of the crank gear. The engine valves are located in the cylinder heads.

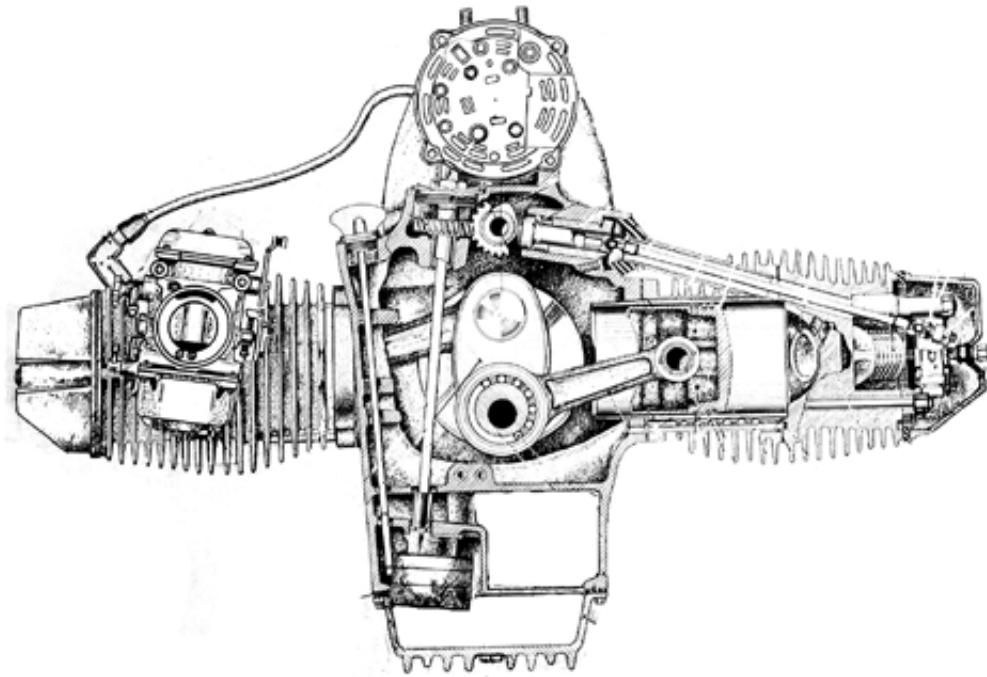

In summer, carefully observe the heating condition of the engine, power transmission units and the running gear mechanisms. Under normal heating conditions of the engine, the temperature of the cylinder heads should not be over 356°F-428°F/180°C-220°C.

During everyday preventive maintenance, clean the engine of mud and dust, paying special attention to the cooling fins as their fouling will impair the efficiency of the engine cooling. Check engine crankcase, cylinders and cylinder heads for oil and fuel leaks. Check carburetor to cylinder head adapter for any cracks or leaks. Visually inspect the alternator for any oil leaks.

LUBRICATION SYSTEM

The motorcycle engine features a dual lubrication system, some parts are force-lubricated by pressure built up by the oil pump, while others by splashing . A full-flow paper oil filter is provided in the lubrication system to prolong the engine life.

Maintenance of lubrication system. During the daily inspection, check the oil level in the engine crankcase and top off the oil if necessary. Warm up the engine before changing the oil. Drain used oil from the engine and the oil filter cavity after having unscrewed the drain plug and filter plug. Change oil filter at the intervals shown in the service coupons. Set the rubber sealing bushing into the filter and fit the filter with the bushing onto the adapter of plug, then screw the latter into the front cover. Now screw in the plug. Fill the engine with 68 oz. oil, or until the top mark of the dipstick is reached.

Let the engine run for 3 - 5 min. Check the oil level again adding oil up to the top groove of the dipstick if needed. During motorcycle service, keep oil level in the engine crankcase close to the top groove of the oil dipstick. Don't ride the motorcycle if the oil level is below the lower mark of the dipstick until sufficient oil is added to raise the oil level to the top mark.

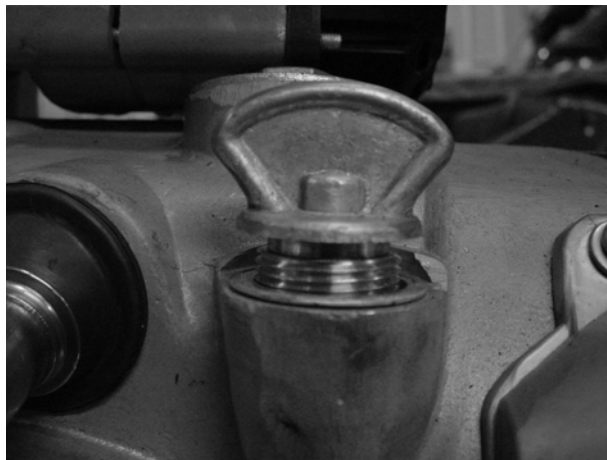

Correct position to measure the oil level

Make sure that the dipstick is screwed down securely after checking the oil level.

FUEL SYSTEM

The fuel system includes the gasoline tank, the three position fuel valve with filter and two carburetors.



Petcock Location



Petcock

Fuel valve (petcock). The top threaded portion of the valve is screwed into the gasoline tank. The petcock is of an automatic shutoff design. Vacuum from the engine opens the valve when the engine is running. When the engine is stopped and loses vacuum, the petcock automatically shuts off.

WARNING: *FILL FUEL TANK SLOWLY TO PREVENT FUEL SPILLAGE. DO NOT OVERFILL ABOVE THE BOTTOM OF FILLER NECK INSERT. LEAVE AIR SPACE TO ALLOW FOR FUEL EXPANSION. FUEL EXPANSION CAN CAUSE OVERFLOW THROUGH THE FILLER CAP VENT ONTO SURROUNDING AREAS. AFTER REFUELING, MAKE SURE FILLER CAP IS SECURELY TIGHTENED.*

Fuel system maintenance. Before a trip, check the tightness of gasoline piping joints, & proper functioning of throttle cables.

IGNITION SYSTEM

The ignition system incorporates the power supplies, ignition coil, Hall Effect pickup, electronic module, two spark plugs, a set of low and high voltage wires and the ignition switch.

The ignition system will provide the spark to the spark plugs from 200 to 6000 RPM. With the engine at rest, the ignition system will draw 100 mA. With the engine running, the ignition system will draw 1.5 Amps. The operating voltage for the ignition system ranges between 7 to 16 Volts. The electronic ignition system will automatically provide the required changes in timing to an accuracy of within + 1°.

Ignition coil The ignition coil has two high voltage terminals, each supplying one of the cylinder spark plugs and operating in conjunction with the Hall Effect pickup.

Periodically, check all wires in the ignition system to be sure they aren't crimped or have loose connections. Loose connections will cause erratic performance and poor fuel economy.

Spark plugs. In certain situations, spark plugs can quickly foul with carbon or soot. The plugs can be cleaned but it is easier to put in a new set of plugs when on the road. We recommend that you purchase an extra set of these plugs from your Authorized Ural Dealer and carry them in the motorcycle at all times.

WARNING: *Do NOT OVERTIGHTEN THE SPARK PLUG WHEN MOUNTING IT ON THE ENGINE, SINCE THIS COULD DAMAGE THE CYLINDER HEAD.*

Functioning of ignition system. Both plugs fire simultaneously on the left and right-hand cylinders, one spark being formed when the compression stroke terminates in one of the cylinders and the other during the exhaust stroke.

IGNITION TIMING

To set the ignition timing, proceed as follows:

- Match the first mark on the flywheel with the center marks on the engine flywheel window.
- Loosen the fastening screws of the microprocessor unit and turn it counterclockwise until it stops.
- Apply power to the ignition system by switching the ignition on.
- Slowly turn the ignition unit clockwise, (the LED should be on)
- Stop turning the microprocessor unit when the LED turns off.
- Tighten the fastening screws of the microprocessor unit and switch the ignition off.

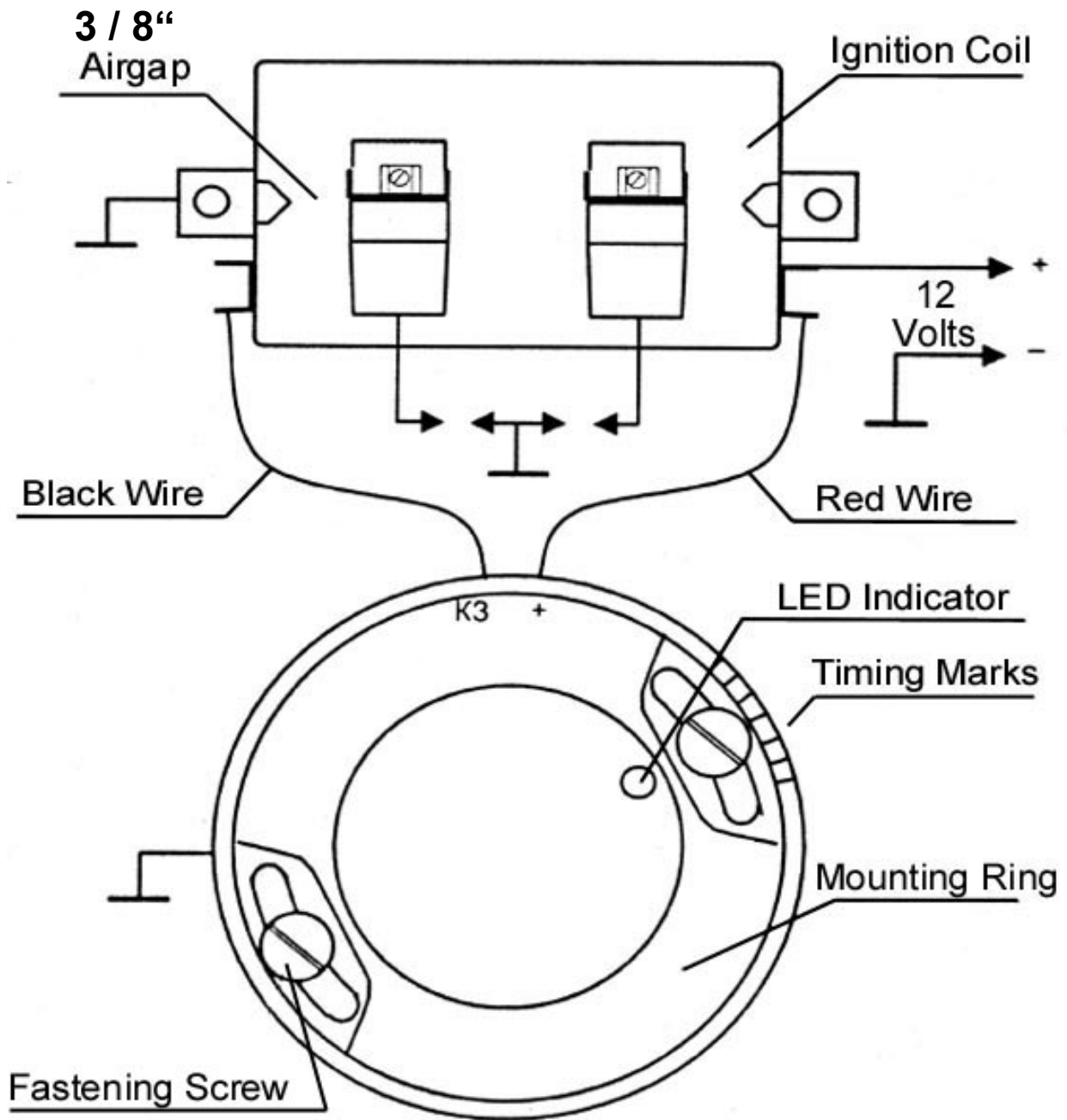

Ignition Module & Coil

Chapter 5

CARBURETORS

32mm CVK Keihin Seike carburetors are used on of the Ural motorcycle. They are preset with fixed mixture jetting and adjust automatically for altitude variations. This is due to the vacuum activation mechanism of these constant velocity type carburetors. Be sure to check the condition of all carburetor adapters and air pipes every time before riding. If the carburetor flanges are in need of replacement, use only genuine Ural replacement or Ural recommended parts.

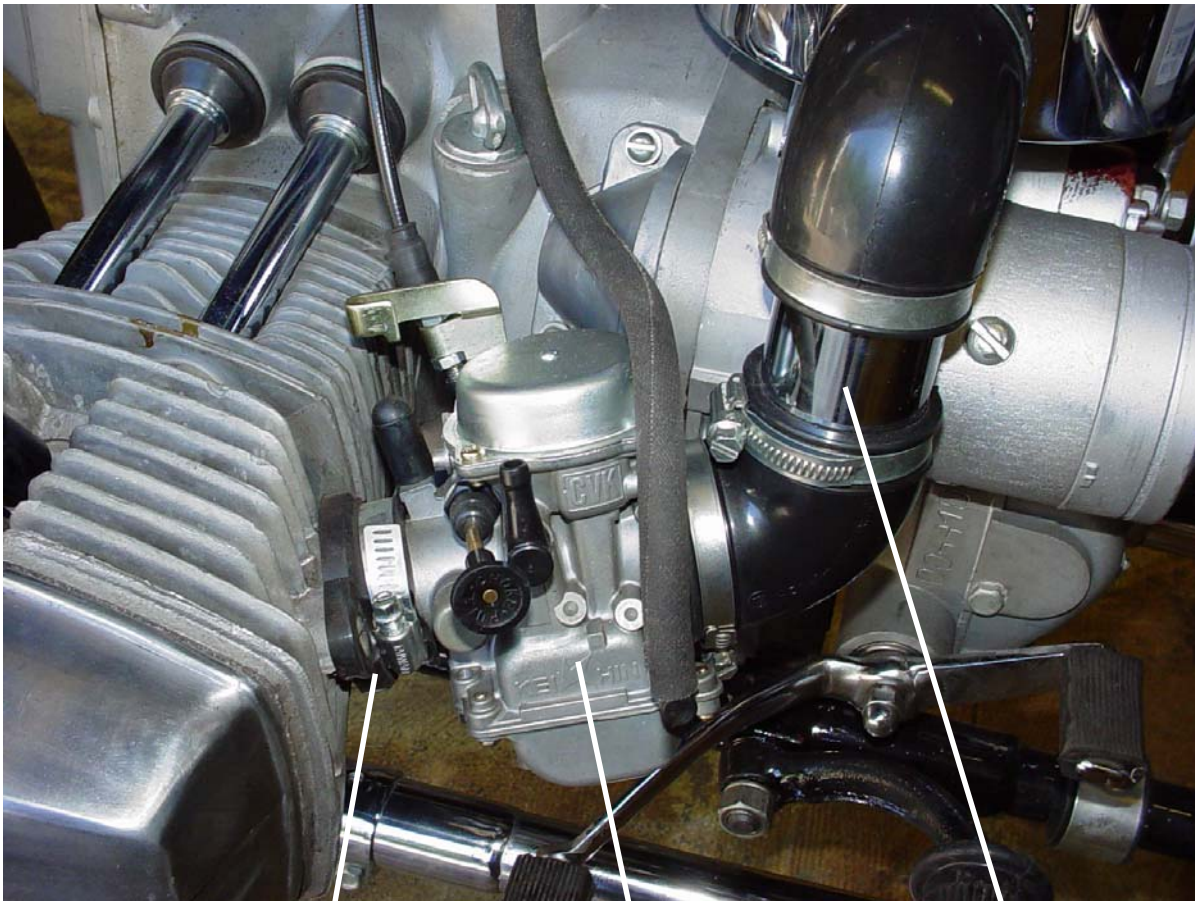

Flange

Carburetor

Branch Pipe

WARNING: *To avoid severe engine damage, do not modify carburetor synchronization, jets, or throttle linkage. This air cooled engine must always run on both cylinders as evenly as possible. Whenever one cylinder is not firing, stop the engine and determine the cause and correct it before proceeding.*

WARNING: *Never use a metal adapter between the carburetor and cylinder head. This will automatically void the warranty and may cause significant damage.*

CARBURETOR MAINTENANCE

The carburetors will require the sediment in the float bowls be drained periodically. This will ensure that any contaminants that have accumulated in the float bowls do not enter the main or idle jets of the carburetors. The fuel can be drained by opening the drains provided on the bottom of the float bowls.

The fuel filters should also be changed every 10,000 km or when they appear to be dirty or not flowing fuel correctly. Changing the filters will ensure that clean fuel is provided to the carburetors and that there is no fuel starvation.

The carburetor to cylinder head adapters should be checked for leaks and cracks every trip. Failure of the adapters will cause the carburetor fuel mixture to become lean and cause internal damage to the engine.

Chapter 6

POWER TRANSMISSION

The power transmission of the motorcycle is comprised of the clutch, gearbox, drive shaft and the final drive.

CLUTCH

The clutch transmits torque from the engine to the gearbox. Disengage the engine from the gearbox during shifting of the gears and during braking to a stop. The clutch provides for smooth starting of the motorcycle from rest, protects the power transmission parts against damage when the engine speed or drive wheel speed is suddenly changed. The clutch is of dry double-disk design. The clutch release mechanism is controlled by the lever on the left grip of the handle bar. With the clutch lever released, the engine is engaged to the gearbox. When the clutch lever is squeezed, the engine is disengaged from the gearbox. **Use the clutch lever for starting from rest and for gear shifting.** Under conditions of heavy traffic, when gears frequently have to be shifted, do not slip the clutch too much, as this will accelerate wear of the disks.

GEARBOX

Shifting the gears is best accomplished by pushing down on the front toe plate for first gear and to downshift from higher gears. To shift up into second, third and fourth gear, use the front toe plate and push upwards quickly and firmly. Since the Ural transmission is a non-synchronized design, it is very important that the clutch be used when shifting. Not using the clutch when shifting can cause damage and void the warranty.

CAUTION: Severe damage due to insufficient lubrication of gears, shafts and bearings can result if the oil level is allowed to get lower than the specified level.

FINAL DRIVE

Maintenance of propeller shaft splines and final drive.

Remove the final drive from the swing arm and pull the final drive towards the rear of the bike. When the drive shaft is free, coat the drive shaft splines with grease. At the same time, use a grease gun to force grease into the drive shaft universal joint.

Typical final drive maintenance includes tightening the nuts which fasten the final drive to the swinging fork arm. Failure to tighten the nuts may result in loose joints and the destruction of the final drive cover. Change the final drive oil as determined by the service coupons. Undo the filler and drain plugs and drain the used oil. Reinsert the drain plug and fill the casing with fresh 20w / 50 Castrol oil and flush the final drive by turning the rear wheel several times. Drain the 20w / 50

Castrol oil and then refill the final drive with the specified lubricant. Reinsert the upper fill plug and wipe off any excess or spilled oil from the final drive.

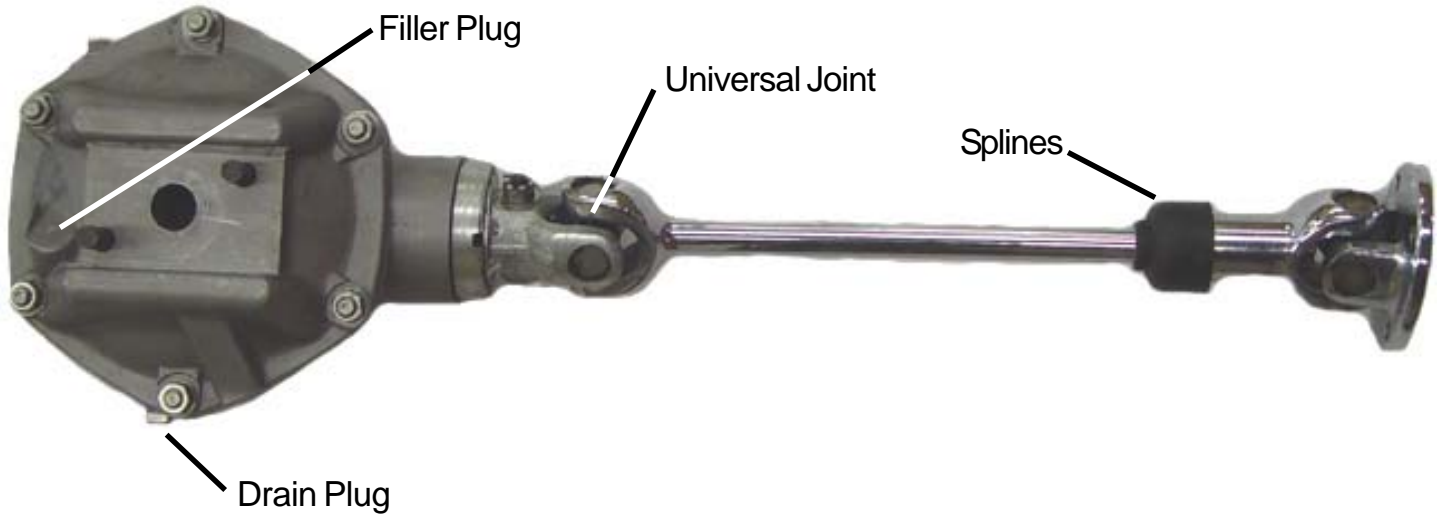

Final Drive Assy



Rear Universal Joint

Chapter 7

RUNNING GEAR

SPRING LOADED HYDRAULIC SHOCK ABSORBER

The suspension features cam-type adjusters used for varying the pretension of the supporting springs to suit the load and the road condition. The degree of tension of the springs is adjustable allowing two positions. The first (lower) position corresponds to the load due to the motorcycle's own weight and the driver's. the second (upper) position of moving cam corresponds to the maximum load.

Care of shock absorbers. Fill the shock absorber with 105 cm³ of hydraulic fluid. Each time during maintenance, check the bolts fixing the top and bottom ends of the shock absorbers for tightness.



FRONT FORK

The front fork used on the wolf model uses a telescopic design. To maintain the fork, change the fluid when it is called for in the service coupons and keep the forks free from dust and dirt. Consult your dealer for details on changing the front fork fluid.

STEERING HEAD BEARINGS

The steering head bearings must be adjusted periodically to avoid excessive play which might cause steering instability. When properly adjusted, the front fork should turn with just a hint of bearing drag, but not free play or obvious resistance to turning. The steering head bearings are of a roller bearing type and are designed for the lifetime of the motorcycle.

WARNING: IMPROPER ADJUSTMENT OF THE STEERING HEAD (E.G. TOO TIGHT) WILL MAKE THE MOTORCYCLE VERY DIFFICULT TO STEER. THIS ADJUSTMENT IS CRITICAL FOR PROPER HANDLING OF ALL MODELS.



Steering Head Bearing Location

Chapter 8

WHEELS AND TIRES

The Ural motorcycle is equipped with wheels that are easy to remove.

Removing wheels. To remove the front wheel, set the motorcycle onto the center stand, lift it by the front wheel and put a rest under the front portion of the motorcycle frame. Slacken the nut of the union bolt at the end-piece base of the fork left-hand leg. Screw out the axle turning it clockwise (left-hand thread) and remove the wheel together with the front brake disc.

To reinstall the front wheel on the motorcycle follow the reverse order of the above operations seeing to it that the brake disc evenly engages with the brake caliper.

To remove the rear wheel of the motorcycle, lift the motorcycle onto the center stand. Undo the rear wheel axle nut and take it off together with the washer, slacken off the nut on the union bolt of the left-hand leg of the swinging arm, pull out the rear wheel axle with the help of a wrench bar and remove the wheel.

To reinstall the wheel on the motorcycle follow the reverse order of operations. Prior to reassembling, wipe the axle and grease it. Fitting the rear axle, turn it as you push it in to avoid jamming.

Care should be taken to keep tires properly inflated. Check before riding when tires are cold. Do not overinflate tires.

Warning: *Never interchange the front for the rear wheels.*

WARNING: *IMPROPER TIRE INFLATION WILL CAUSE ABNORMAL TREAD WEAR AND COULD RESULT IN UNSTABLE HANDLING. UNDER-INFLATION COULD RESULT IN THE TIRE SLIPPING ON THE RIM.*

**Front
tire pressure**



1.5 Bar

**Rear
tire pressure**



2.5 Bar

**Front
tire pressure**



or 150 kPa

**Rear
tire pressure**



or 250 kPa

WARNING: RIDING WITH EXCESSIVELY WORN, UNBALANCED OR IMPROPERLY INFLATED TIRES IS HAZARDOUS AND WILL ADVERSELY AFFECT TRACTION, STEERING AND HANDLING. SAME AS ORIGINAL EQUIPMENT TIRES MUST BE USED. OTHER TIRES MAY NOT FIT CORRECTLY AND MAY BE HAZARDOUS TO USE.

BECAUSE TIRES, TUBES AND WHEELS ARE CRITICAL SAFETY ITEMS AND SERVICING OF THESE ITEMS REQUIRES SPECIAL TOOLS AND SKILLS, WE RECOMMEND YOU SEE YOUR URAL DEALER FOR THESE SERVICES.

TIRE DATA

WARNING: FOR YOUR OWN PERSONAL SAFETY, TIRES AND TUBES MUST BE CORRECTLY MATCHED TO WHEEL RIMS. SEE YOUR AUTHORIZED URAL DEALER FOR FURTHER INFORMATION. MISMATCHING TIRES, TUBES AND RIMS MAY RESULT IN DAMAGE TO THE TIRE BEAD DURING MOUNTING OR MAY ALLOW THE TIRE TO SLIP ON THE RIM, POSSIBLE CAUSING TIRE FAILURE. IN ADDITION, USING TIRES OTHER THAN THOSE SPECIFIED MAY ADVERSELY AFFECT MOTORCYCLE STABILITY. PROTECTIVE RUBBER RIM STRIPS MUST BE USED. TIRE SIZES ARE MOLDED ON THE TIRE SIDEWALL. TUBE SIZES ARE PRINTED ON THE TUBE.

URAL tires that have been tested by the manufacturer to ensure compliance with DOT requirements are available from your Authorized IMWA Dealer.

WARNING: MAXIMUM INFLATION PRESSURE MUST NOT EXCEED SPECIFICATION ON TIRE SIDEWALL.

WARNING: WHEN TIRES ARE WORN TO A TIRE CENTER TREAD DEPTHS OF 3/32 IN, THEY SHOULD BE REPLACED.

WHEEL AND TIRE MAINTENANCE

During the pre-trip inspection, check air pressure in the tires.

Check axle and spokes for safe fastening, be sure to tighten the spokes or fasteners and eliminate play as soon as they get loose or demonstrate excessive play.

While lubricating, consult the Lubrication Chart.

WARNING: *WHEEL TRUING INVOLVING MORE THAN 2 TURNS OF ANY SPOKE NIPPLE SHOULD BE ACCOMPLISHED WITH THE TIRE DISMANTLED SO THAT SPOKE ENDS CAN BE CHECKED TO ENSURE NO SPOKES PROTRUDE INTO THE INNER TUBE.*

Wheel Construction

Two adjustable tapered roller bearings are pressed into the wheel hub, which are prelubricated with LITOL-24 type grease. Depending on motorcycle version the wheels with aluminum cast brake drum or disc type may be used. The adjustment of bearings is the same for both styles of wheel.

Adjustment of Wheel Bearings.

The life of wheel bearings is extended by proper adjustment. Check the condition of bearings and adjust them every 5000 km. To adjust the bearings proceed as follows:

- Remove the wheel from the motorcycle;
- Fit the rear wheel axle (without protective cap), tighten it by nut with the aid of a bushing, 100 mm long, with 21 mm ID and 25...30 mm OD, or a set of bushing of given size.
- Determine if there is a play by turning the axle (but not the wheel on the axle) and rocking it, slacken off the lock nut.
- Screw the seal nut up to the limit, then release it by 1/6.. 1/8 of the turn so that the axle-bushing system rotates without play, easily and without jamming. The overtightening of bearings is strictly prohibited.
- Tighten the lock nut without effecting the bearing adjustment.
- Pull the axle out.
- Put the wheel onto the motorcycle.

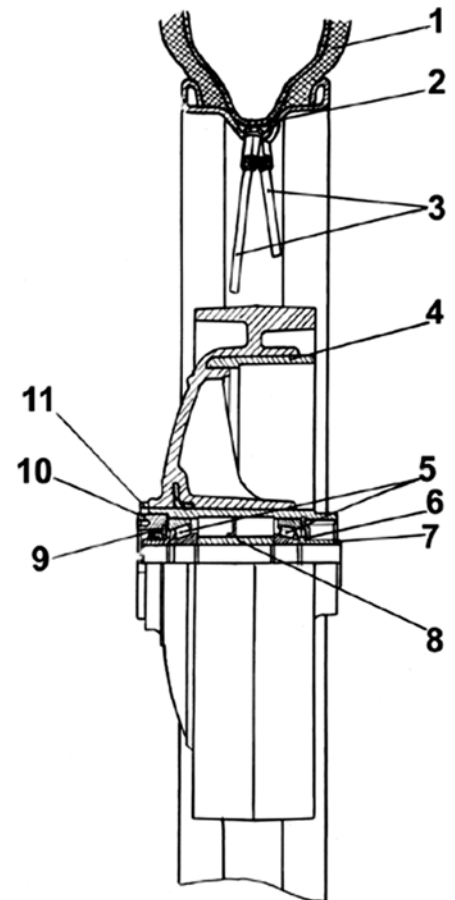

Chapter 9

BRAKES

The motorcycle is equipped with a hydraulic disc brake in front and hydraulic drum on the rear. The hydraulic disc brake consists of a caliper, brake pads and a wheel disc.



The front brake is a hydraulic disc brake.

Front Brake
Reservoir



The front brake hydraulic reservoir is located on the right handlebar.

Differential
Dipstick



Brake Line

The **rear wheel brake** is mounted in the rear hub, and is actuated via a hydraulic master cylinder linked to the brake pedal.



Rear Brake Hydraulic Reservoir

Brakes should be “burnished in” during the initial running in period. Follow burnishing procedures carefully. Make approximately 100 stops using 75% of full braking power. This can be done over several periods and need not be done in one session. Choose an area with clean, dry pavement and no obstructions. Travel in a straight line and apply both the hand (front) brake as well as the foot (rear and sidecar) brakes. This procedure will ensure maximum braking performance during the running-in period and is essential before raising your top speed, after your Ural has been carefully run in (after 1,500 km).

WARNING: *BECAUSE BRAKE PERFORMANCE IS A CRITICAL SAFETY ITEM, WE RECOMMEND THAT YOU SEE YOUR IMWA DEALER FOR THESE SERVICES.*

BRAKES MUST BE INSPECTED FOR WEAR AS PER THE SERVICE COUPONS *IF THE BRAKE SHOE FRICTION MATERIAL IS 1/16 IN. THICK OR LESS (THE THICKNESS OF A NICKEL) THE SHOES MUST BE REPLACED IMMEDIATELY. FAILURE TO REPLACE PADS WHEN NECESSARY COULD RESULT IN BRAKE MALFUNCTION AND PERSONAL INJURY. IF YOU RIDE UNDER ADVERSE CONDITIONS, STEEP HILLS, HEAVY TRAFFIC, ETC., MORE FREQUENT INSPECTION, 1,000 KM OR LESS, WILL BE NECESSARY. THE HYDRAULIC BRAKE FLUID SHOULD BE INSPECTED BY REMOVING THE TOPS OF THE HYDRAULIC RESERVOIRS & CHECKING FOR ADEQUATE FLUID LEVELS.*

IMPORTANT NOTE: *Ural motorcycles utilize hydraulic fluid graded as DOT 3. If the hydraulic fluid system should ever require additional brake fluid, only hydraulic fluid either rated as DOT 3 or compatible with DOT 3 may be used. Fluids graded as DOT 4 are compatible, and therefore may be used.*

Chapter 10

ELECTRICAL EQUIPMENT

The electrical equipment of the motorcycle includes power supplies, auxiliary instruments and electric wiring.

Electric power supplies are a battery and an alternator with a built-in rectifier.

A single wire system is used for wiring the electric circuits, i.e. a single wire carries power to the electrical devices and the frame and engine serve as the second wire (called the "ground"). The negative pole of the battery is connected to the motorcycle frame through the battery master switch. The alternator makes electrical contact to the motorcycle engine and frame through its mounting bolts.

Battery supplies electric power to all the systems of the motorcycle when the engine (and alternator) have stopped.

An alternator with a built-in rectifier is driven by the engine camshaft driven gear. The alternator is secured with two studs on the engine crankcase. At the drive side, the alternator cover is so designed that by turning the alternator on the studs, the backlash adjustment of the gear mesh gap can be made.

Electric horn. The motorcycle is equipped with a horn which sounds when the ignition is on and the horn button is pressed. The horn can be tuned for loudest performance with an adjusting screw located at the rear portion of the horn body.

Headlight. A 7" diameter DOT approved sealed beam headlight is used on the Ural. Adjust it so that the high-beam is horizontal when the motorcycle is in its normal loaded condition.

ELECTRICAL CIRCUITS

Lead acid batteries such as those found in motorcycles are designed for a charging voltage of 14.25 volts. Batteries which are subjected to greater than 14.25 volts for extended periods of time can suffer permanent damage due to the electrolyte boiling dry. Charging voltage of less than 14.25 volts will result in an inadequate charge delivered to the battery.

Automotive batteries operate at 12 volts. This is not enough voltage to harm people in any way. However, the battery stores a huge amount of electricity in the form of electrons. If the electrons

are allowed to flow from the battery without restriction, then the wires carrying the electricity will become hot enough to melt. The melting wires are extremely dangerous and can easily burn you.

Most problems in automotive electrical circuits are caused by poor connections. Make sure that all connection points are clean and tight.

If the flow of electricity through a wire is interrupted due to a break in the wire or a poor connection, then the circuit is said to be “an open circuit”

The flow of electricity through a circuit always takes the path of least resistance. If there is an accidental path of extremely low resistance created in a circuit, the circuit is said to have a “short circuit” A short circuit will usually result in the melting of the fuse protecting that circuit.

ELECTRICAL EQUIPMENT MAINTENANCE

During the daily preventive inspection, check the functioning and the condition of the electrical equipment. Inspect and or replace the spark plugs and ignition leads as required in the Service Coupons. The gap is readjusted by bending the end of the side electrode.

Care of alternator. In the course of daily inspection, check the fastening of wires to the alternator terminals, fastening of the alternator on the engine crankcase, backlash of the gears (by listening). In case of too little backlash of the drive gear, excessive wear and overheating of the alternator bearings take place.

Check for proper tightening of:

- nuts of the binding post bolts
- the alternator clamping screws
- the alternator fastening nuts

as often as outlined in the Service Coupons.

WARNING: Do not add any electrical accessories to your Ural motorcycle, as this may void portions of the warranty

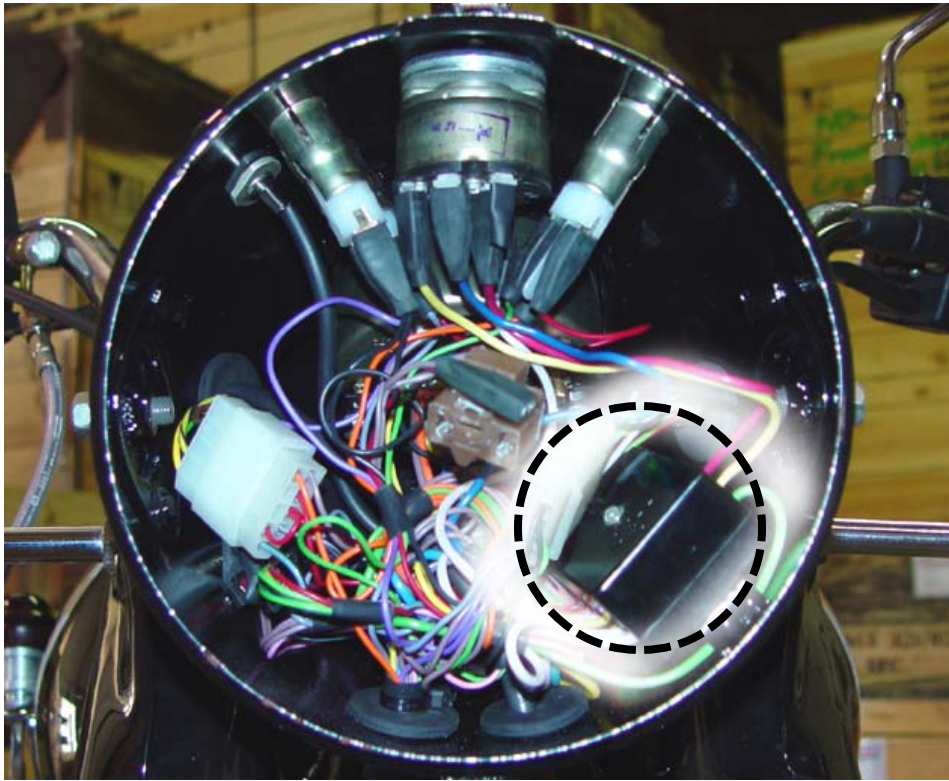

Fuse box (Inside of headlight bucket)



The headlight relays are located under the fuel tank

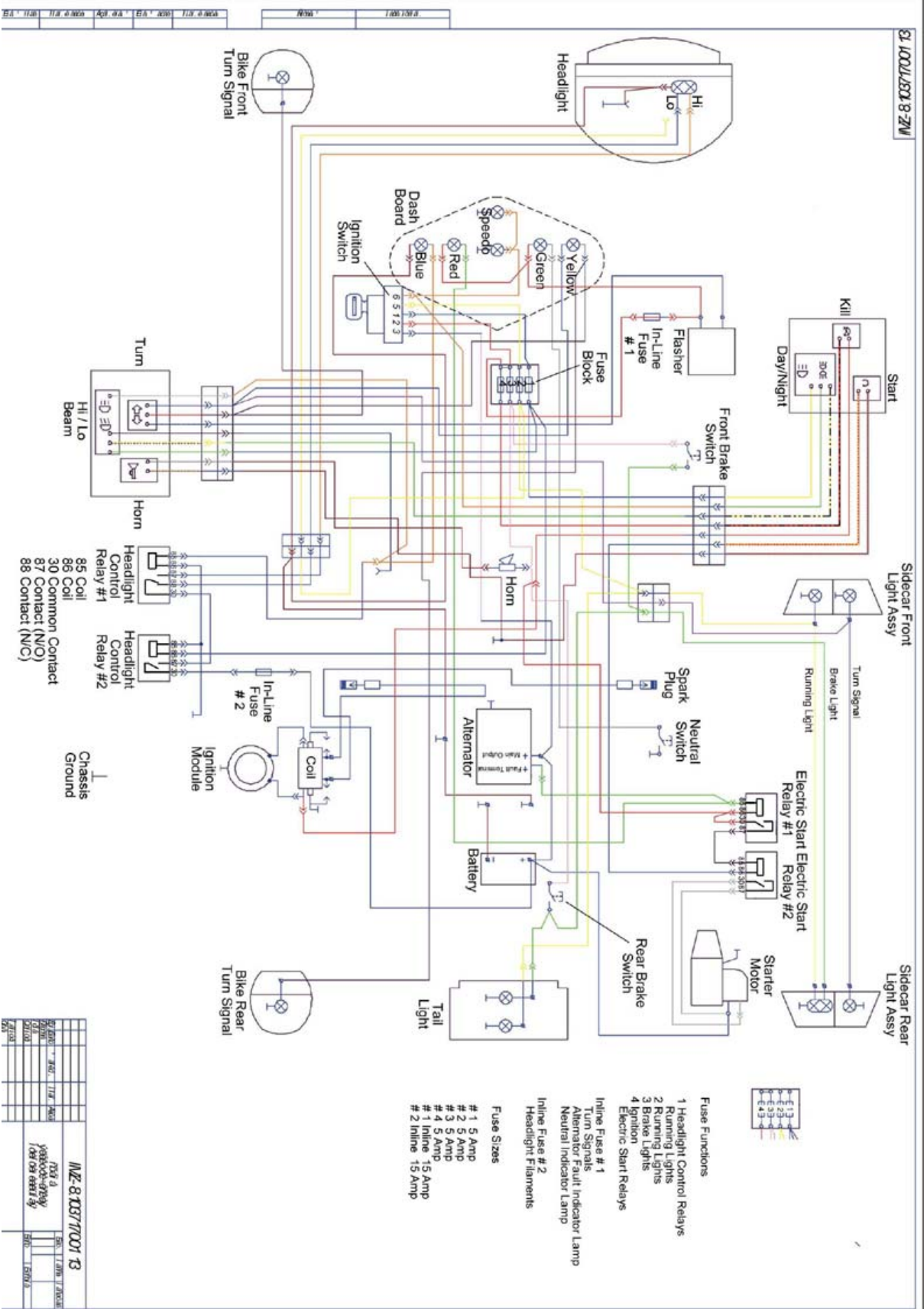

Wiring Diagram

Chapter 11

MAINTENANCE OF MOTORCYCLE

Maintenance should be performed after the specified total kilometers run irrespective of the technical condition of the motorcycle.

Different service duties and technical condition of the motorcycle may necessitate a change in the intervals.

The Lubrication Chart indicating lubrication points of the motorcycle is given in Fig. 35. A summary of lubrication maintenance is given in the lubrication chart.

Cosmetic Maintenance

The enjoyment and resale value of your vehicle is greatly enhanced by consideration to the “look” and cosmetic perfection of your vehicle. Due to the numerous metal surfaces on a motorcycle, special care must be taken to prevent rust from occurring and/or to removed any rust or oxidation.

LIST OF RECOMMENDED LUBRICANTS

Lubrication Area	Detergent Oil Quantity
Engine	20w/50 Castrol 68 oz. (2.0 L) ¹
Transmission	20w/50 Castrol 30.6 oz. (0.9 L) ²
Single Wheel Final Drive	80/90 wt.Gearlube 3.5 oz. (105 ml)

1 68 oz. is an approximate measure. The exact oil quantity will be whatever is required to bring the oil level at the top mark of the dipstick.

2 34 oz. is an approximate measure. The exact oil quantity will be whatever is required to bring the oil level up to the bottom thread of the transmission oil filler hole.

Note: Some leakage, seepage or dripping of oil and/or other lubricants is normal. It is not indicative of any malfunctioning and therefore is not covered as a warranty item unless motorcycle operation or safety are materially affected.

LUBRICATION CHART

PART TO BE LUBRICATED

Engine crankcase
Transmission
Air cleaner
Telescopic forks
Final Drive
Brake pedal shaft
Drive shaft universal joint
Lever pins & end pieces of clutch & hand brake cables
Wheel bearing
Front forks
Carburetor throttle control twist grip
Speedometer flexible drive cable & speedometer axle
Steering column bearings

LUBRICANT

20W/50 Detergent Oil
20W/50 Detergent Oil
JR Filter Oil
5wt-10wt Fork Oil
80/90 Gear oil
Grease
Grease
Grease
Grease
Spindle oil & WD-40
Grease
Spindle oil
Grease

REQUIRED LUBRICATION

The Ural has been certified for EPA with **SAE 20W/50 petroleum based detergent oil**. This oil is used in both the engine and transmission.

CARE OF MOTORCYCLE PAINT

When washing the motorcycle, use a weak stream of cold or slightly heated water. Never use a pressure washer! Do not remove dust and mud by rubbing the surface with a dry cloth as sand particles will degrade the surface and the paint will rapidly lose its brilliance. While washing, do not use soda solution, kerosene, citric acids or mineral oils. If the surface is stained with mineral oil, degrease by wiping with a rag. If after removal of mud and dust with a jet of water, some dirt is left on the surface, remove it with the help of a sponge, a soft hair brush or a flannel and water, but not allowing separate water drops to dry out on the surface. Finally, polish the painted surfaces with a dry soft flannel.

To repair painted areas, each motorcycle is furnished with a bottle of matching touch up paint.

For patching proceed as follows:

- clean the surface with turpentine
- rub the damaged spot with a waterproof abrasive cloth and water rub thoroughly
- paint using a soft brush or a spray gun.

After patching, let the surface dry in air for 15 minutes. Then proceed with drying at 212°F-248°F/ 100°C-120°C with the aid of heat reflector or an electric lamp until the coat is perfectly dry.

Bear in mind that enamels are flammable. Color match may not be perfect due to humidity, fading, temperature and other variables.

The painted surfaces of the motorcycle feature natural gloss. In case some dull spots appear, remedy them by polishing as follows. Take a solution of wax polishing compound and having washed the dull spots thoroughly, smear a thin film of the compound with a soft wad (cotton, cotton gauze or flannel) over the surface. Rub the polishing compound making circular motions with the wad. In 3 - 5 min. of drying, wipe the surface with a clean dry piece of cloth or flannel until luster appears.

PRESERVATION AND STORAGE

If the motorcycle is put in storage for the season, arrange it on supports and proceed with the preservation treatment. Check that the wheel tire pressure is within specifications. Store the motorcycle away from acids, alkalis, mineral fertilizers and other harmful substances.

Prior to placing it in storage, clean the bike thoroughly, drain the carburetors, or start the engine and let it run with the gasoline cock closed to remove gasoline in the float chambers of carburetors. Then spray storage oil (WD40) into each cylinder through the spark plug holes. Turn the crankshaft by depressing the kick lever pedal to distribute lubricant over the interior of the cylinders. Lubricate the surfaces of chrome and zinc plated parts with a rust inhibitor. Smear all the points provided with grease cups with commercial grease. Seal the outlet holes of the mufflers.

Before starting a trip on the motorcycle that was under preservation, proceed with the jobs listed in the section "Pre-Trip Preliminaries".

Winter Considerations

Motorists in many areas of the US experience the use of salt and other chemicals that are applied to road surfaces in the winter.

Salt or other caustic chemicals should always be removed from your bike's surfaces with fresh water as soon as possible.

Undercoating of fenders is recommended for those areas with salt and/or fine gravel or sand. See your dealer for details.

BATTERY

Storage batteries on the motorcycle should function at ambient air temperature from -40°C to plus 60°C/ 40°F to 140°F.

As the battery is in service:

- regularly check the voltage for 12.8 - 13.2 V
- do not allow the battery to discharge.
- use only distilled water to maintain the normal level of electrolyte.
- coat bolts, nuts, washers and tips with petroleum jelly or battery grease. Use two wrenches for clamping or undoing the nuts to avoid breaking battery parts.

Warning: *Do not short the terminals together to check for sparking.*

Before storage, fully charge the batteries, wash the battery surface with water and wipe dry, clean the bolts and nuts of dirt.

WARNING: *BATTERIES CONTAIN SULFURIC ACID WHICH CAN CAUSE SEVERE BURNS. AVOID CONTACT WITH SKIN, EYES OR CLOTHING. ANTIDOTE: EXTERNAL — FLUSH WITH WATER. INTERNAL — DRINK LARGE QUANTITIES OF WATER FOLLOWED BY MILK OF MAGNESIA, VEGETABLE OIL, OR BEATEN EGGS. CALL DOCTOR IMMEDIATELY.*

Caution: When charging the battery, disconnect the positive terminal (+) from the battery to prevent damage to the electrical components *Never jump-start the motorcycle!*

WARNING: *BATTERIES PRODUCE EXPLOSIVE HYDROGEN GAS AT ALL TIMES — ESPECIALLY WHEN BEING CHARGED. KEEP CIGARETTES, OPEN FLAME, AND SPARKS AWAY FROM BATTERY AT ALL TIMES. VENTILATE AREA WHEN CHARGING BATTERY. ALWAYS PROTECT HANDS AND PROTECT EYES WITH SHIELD OR GOGGLES WHEN WORKING NEAR A BATTERY OR ACID. KEEP BATTERIES AND ACID OUT OF THE REACH OF CHILDREN!*

CAUTION: *If battery is filled to a higher level than specified, some of the solution will be forced out through the vent tube when battery is charging. This will not only weaken the solution, but also may damage parts near the battery. To prevent battery case damage caused by pressure buildup, be sure vent tube is properly routed and not kinked or obstructed.*

LIST OF INDIVIDUAL TOOL SET, SPARE PARTS, ACCESSORIES & DOCUMENTS

DESCRIPTION	QTY	DESCRIPTION	QTY
Tools			
1. Wrench 7 x 8	1	1. Air Pump	1
2. Wrench 10 x 12	1	2. Air Pressure Gauge	1
3. Wrench 13 x 14	1	3. Ignition keys	2
4. Wrench 14 x 17	1		
5. Wrench 19 x 22	1		
6. Socket wrench 10 x 12	1		
7. Socket wrench 10 x 13	1		
8. Socket wrench 19 x 21	1		
9. Wrench 27 mm	1		
10. Double head wrench	1		
11. Spanner wrench	1		
12. Spanner wrench assembly	1		
13. Screwdriver 150 mm	1		
14. Screwdriver 100 mm	1		
15. Punch	1		
16. Allen wrench	1		
17. 22mm Round wrench (Patrol only)	1		
		Set of Spares	
		1. Oil filter element	1
		2. Fuses	2
		3. Touch up paint	1
		Documents	
		1. <i>Owner's Manual</i>	1

Chapter 12

SAFE OPERATING RULES

Before operating your Ural it is your responsibility to read and follow operating and maintenance instructions in this manual and follow these basic rules for your personal safety.

- Know and respect the Rules of the Road in your state.
- Use only Ural approved parts and accessories.
- Gasoline is extremely flammable and is explosive under certain conditions.
- Refuel in a well ventilated area with the engine stopped. Do not smoke or allow open flames or sparks when refueling or servicing the fuel system. Always close the fuel supply valve when the engine is not running to prevent flooding of the carburetors. Do not overfill fuel tank. Fill tank slowly to prevent fuel spillage. Leave air space to allow for fuel expansion. Do not fill more than about an inch below the lower edge of the tank filler.
- Motorcycle exhaust contains poisonous carbon monoxide gas. Do not inhale exhaust gases and never run the engine in a closed garage or confined area.
- Before starting engine, check for proper operation of brake, clutch, shifter, throttle controls, correct fuel and oil supply.
- A new motorcycle must be operated according to a special break-in procedure (see Running-In The New Motorcycle).
- Operate the motorcycle only at moderate speed and out of traffic until you have become thoroughly familiar with its operation and handling characteristics under all conditions. If you are an inexperienced rider we recommend that you obtain information and training in correct motorcycle riding technique.
- Do not exceed the legal speed limit or drive too fast for existing conditions. Always reduce speed when poor driving conditions exist. High speed increases the influence of any other condition affecting stability and the possibility of loss of control.
- Pay strict attention to road surfaces and wind conditions. Any two or three-wheeled vehicle may be subject to upsetting forces. Wind blasts from passing trucks, holes in the pavement, rough road surfaces, rider control error, etc., may influence the handling characteristics of your motorcycle. Should this happen, reduce speed and guide the motorcycle with a relaxed grip to a straightaway position. Do not brake abruptly or force the handlebars as this may aggravate an unstable condition. New riders should gain experience under various conditions while driving at moderate speeds.
- Operate your motorcycle defensively. Remember, a motorcycle does not afford the same protection as an automobile in an accident.
- Wear an approved helmet, clothing and footgear suited to motorcycle riding. Bright or light colors are best for greater visibility in traffic especially at night. Avoid loose flowing garments and scarves.
- The exhaust pipes and mufflers get very hot when the engine is running and remain too hot to touch for some time after the engine is shut off.
- Wear clothing that will completely cover the legs when riding and avoid contact with the exhaust system.

- Do not allow others, under any circumstances to operate your motorcycle unless you are certain that they are experienced, licensed riders and are familiar with the operation of your particular motorcycle.
- When leaving the motorcycle unattended, remove ignition key from switch. Protect your motorcycle against theft.
- Safe motorcycle operation requires mental awareness and good judgment combined with a defensive driving attitude. Don't allow fatigue, alcohol or drugs to endanger your safety or the safety of others.
- Maintain your motorcycle in proper operating condition in accordance with the service coupons in this Owner's Manual. Particularly important to motorcycle stability is the tire inflation pressure, tread condition, and proper adjustment of wheel bearings and steering head bearings.
Do not operate motorcycle with loose, worn or damaged steering system or front or rear suspension system as handling will be adversely affected. Contact your dealer for repair of steering or suspension system wear or damage.
- Do not tow a trailer.
- At street intersections, give the right-of-way to the vehicle on your right. Do not presume too much when you have the right-of-way, the other driver may not know you have it.
- Always signal when preparing to stop or turn.
- All traffic signs, including those used for the control of traffic at intersections, should be obeyed promptly and to the letter. SLOW DOWN signs near schools and CAUTION signs at railroad crossings should always be observed and your actions governed accordingly.
- Never anticipate a traffic light. When a change is indicated from GO to STOP (or vice versa) in the traffic control systems at intersections, await the change.
- When intending to turn to the left, give signal at least 100 feet before reaching the turning point. Move over to the centerline of the street (unless local rules require otherwise), slow down passing the intersection of the street and then turn carefully to the left.
- In turning either right or left, watch for pedestrians as well as vehicles.
- Do not leave the curb or parking area without signaling and seeing that your way is clear to drive into moving traffic. A moving line of traffic has the right-of-way.
- See that your license tags are installed in the position specified by law and that they are clearly visible under all conditions. Keep them clean.
- Ride at a safe speed — a speed consistent with the type of highway you are on, and always note whether the road is dry, oily, icy or wet. Each varying condition on the highway means adjusting your speed accordingly.

Chapter 13

WARRANTY AGREEMENT

Irbit MotorWorks of America, Inc., (IMWA, Inc.) warrants to the first retail purchaser of the URAL® motorcycle from an Authorized IMWA Dealer and each subsequent owner that the motorcycle is free from defects in materials and workmanship for the period stated below.

To Qualify For This Warranty

- The URAL® motorcycle must be purchased from a Dealer within the United States who is authorized by IMWA, Inc. to sell motorcycles. (See www.imz-ural.com for the authorized IMWA Dealer list)
- Prior to delivery to the purchaser, the Dealer who is authorized by IMWA, Inc. to sell motorcycles must perform set-up and pre-delivery service.

Warranty Time Period

- Duration: two (2) years parts and labor.
- There is no mileage limitation.
- Coverage begins the date the motorcycle is sold to the first retail purchaser and the warranty registration card is received by IMWA, Inc.

Warranty Coverage

- IMWA, Inc. will repair or replace, at its options, any part (including parts of the emission control systems) that is found to be defective in material or workmanship under normal use for the applicable time period.
- In cases when warranty repair takes longer than 14 days, the warranty time period (see **Warranty Time Period**) is extended for the time period of repair, during which the motorcycle could not been ridden due to failures.
- IMWA, Inc. provides warranty for spare parts for the following period of time starting from the time of purchase of the parts by a Dealer or retail customer.
 1. Engine – 12 months
 2. Gearbox – 12 months
 3. Final drive – 12 months
 4. Alternator – 6 months
 5. Electric starter – 6 months
 6. Ignition – 6 months
 7. The rest of the motorcycle parts and parts assemblies - 30 days

The above applies ONLY in cases when Dealer or retail customer identifies defects before using parts and/or assemblies or these defects are identified during performance AND provided these parts have been properly installed by IMWA, Inc. or authorized IMWA Dealer.

- IMWA, Inc. will reimburse non-IMWA repair shops performing warranty repair for labor only if all the warranty processing and approval procedures are completely fulfilled and/or carried out according to IMWA, Inc. guidelines stated in the Warranty Claim Filing Procedures (see **Warranty Claim Filing Procedures**).

Warranty Terms – Dealer Demo Bikes

Warranty term for the retail buyer begins on the day that title transfers to the first retail purchaser. Thus, during the period a Dealer uses a bike for demonstration or show purposes, the warranty will be honored to the Dealer, provided proper maintenance procedures are followed during the demonstration period. If the Dealer sells the motorcycle to another Authorized IMWA Dealer, the warranty will continue, and the limited time warranty (described above) will begin on the day that title transfers to the first retail purchaser.

The exception to the above is if a motorcycle has over 1,500 km on it at the time of transfer to the retail buyer, the bike remained on the Dealer's floor for over 12 months from the time of purchase from IMWA, Inc. or if the Dealer

has voided the warranty through improper maintenance, usage, modifications, etc. Any failure of the speedometer assembly on any floor models will require the defective speedometer assembly to be returned to IMWA, Inc. in Redmond, WA. In any of the above cases, Dealer's State Law and mileage requirements will determine whether the sale of a demonstrator motorcycle shall be considered new or used.

Modifications of IMWA, Inc. Limited Warranty for URAL® Motorcycles for Commercial Uses

All aspects of the normal non-commercial warranty apply except:

1. Parts and labor coverage limited to the first 10,000 km of mileage or one (1) year, whichever comes sooner (rather than limited mileage).
2. Parts only coverage limited to the second 10,000 km of mileage (up to 20,000 total km) or two (2) years, whichever comes sooner (rather than unlimited mileage).
3. All scheduled service work outlined in the service coupons at the end of the Owner's Manual must be performed at an Authorized URAL® Dealer or a service facility pre-approved in writing by IMWA, Inc.

Note: Copies of all completed service coupons must be sent to IMWA, Inc. within 30 days of completion of each coupon. Failure to adhere to this requirement will void the warranty.

4. All personnel who operates the motorcycle must sign a statement that they have studied the **Owner's Manual** and have gone through the sidecar motorcycle driving practice before taking the commercially outfitted URAL® outfit on the public roads.

A copy of a signed and dated statement of completion by each driver and instructor must be sent to IMWA, Inc. within 30 days of completion of training. Failure to adhere to this requirement will void the warranty.

Warranty Disclaimers

Limitations & Exclusions

Disclaimer of Consequential Damage & Limitation of Implied Warranties

Irbit MotorWorks of America, Inc. disclaims any responsibility for:

- Loss of time due to warrantable issue
- Loss of use of motorcycle
- Transportation expenses
- Any other incidental or consequential damage (i.e. storage)

Duration of Implied Warranties

Any implied warranties, including the implied warranty of merchantability and fitness for a particular purpose are limited to the duration of this written warranty.

State Laws May Vary

The previous listed limitations or exclusions may not apply to a motorcycle because of state laws. Some states may not allow limitations on how long an implied warranty lasts. Some states may not allow exclusion or limitation of incidental or consequential damages.

These Warranties Do Not Cover:

1. Failures or required services that are not due to a defect in material or factory workmanship
2. Parts or accessories affected or damaged by:
 - Lack of required maintenance
 - Owner abuse
 - Accident and/or collision
 - Misuse
 - Normal wear
 - Neglect
 - Improper installation
 - Unsuitable use in an application for which the part was not designed
 - The incorporation or use of unsuitable attachments or parts
 - The unauthorized alteration of any part or system
 - Deterioration from the elements
 - Failure to follow running-in (break-in) procedure
3. Replacement of expendable maintenance items beyond the first scheduled maintenance, including, but not limited to:
 - spark plugs
 - filters
 - lubricants
 - compliance fittings
 - tires (see Owners Manual)
 - gaskets
 - fuel line
 - fuses
 - bulbs
4. Paint and/or decal fading, peeling, blistering, chipping or rusting.
5. Use for the following activities; such use will VOID coverage:
 - Racing
 - Competition
 - Rental or other commercial use
 - Alteration of engine or drive train
 - Any operation or use outside of that described in Owner's Manual
6. Alteration of the odometer so that the actual mileage cannot be determined; alteration will VOID coverage.
7. Use of bike for towing purpose will VOID warranty

Dealer and Owner Responsibilities

Dealer Is Responsible For:

- Thoroughly check and road test new units before delivery.
- Fill out (**Please Print!!!**), sign and send Warranty Registration and Card of Delivery to IMWA, Inc. within 3 business days of the sale of Motorcycle.
- Accept all eligible motorcycles for warranty service regardless of selling Dealer.
- Keep records of all warranty work.
- Attend service schools as provided by IMWA, Inc.
- Submit warranty claims to IMWA, Inc. IN WRITING within 10 business days of the repair date.
- Obtain authorizations for warranty repairs from IMWA, Inc. when estimated cost will exceed \$100.00 (see Advance Warranty Authorization).
- Send failed parts and/or parts assemblies for an inspection to IMWA, Inc. within 3 (three) business days upon IMWA's request at IMWA, Inc. shipping expense.
- Provide digital pictures of failed parts and/or parts assemblies immediately upon IMWA's request.

Customer Is Responsible For:

- Operate and maintain the motorcycle according to the IMWA, Inc. Owner's Manual and service schedule.
- Retain all service records for future reference.

Warranty Claims Filing Procedure

IMWA, Inc. will compensate Dealer for his labor based on authorized procedures only and at the published flat rate schedule (Appendix B) applied to the Dealer's approved shop hourly rate.

1. Dealer will fax a warranty parts request to IMWA, Inc. on a **Warranty Claim Form** (Appendix A) for all warranty parts.
2. Irbit MotorWorks of America, Inc. will review and when approved, will ship parts within 48 hrs and notify Dealer if repair will be covered under factory warranty.
3. Dealer must submit claims for labor reimbursement within 10 business days upon receipt of warranty parts and completion of authorized repair.
4. All submitted claims for labor reimbursement must fall within published flat rate schedule (Appendix B) to be approved.
5. Parts credit will be issued to the Dealer's account before the 10th of the month.
6. Warranty repairs estimated to exceed **\$100.00** in parts and labor must receive prior approval from IMWA, Inc.
7. **Any** repair that involves **final drive, gearbox** or internal invasive examination of **engine** must receive prior approval from IMWA, Inc.

Engines, Gearboxes and Final Drives will be replaced on warranty only after the Dealer has accomplished the following:

1. A qualified IMWA trained technician has completed a thorough external examination, documented findings and has faxed/e-mailed it to IMWA, Inc. with comments of technician
2. IMWA, Inc. technical staff has reviewed and discussed the problem with the Dealer's technician
3. IMWA, Inc. issues Return Merchandise Authorization No. and call tag after authorizing return of item and faxes it to Dealer

After IMWA, Inc. inspection of engine or gearbox or final drive:

1. If engine/gearbox/final drive is found to be defective due to factory parts or assembly failure, the appropriate warranty order will be processed and the flat rate for removal and re-installation of the engine/gearbox/final drive will be authorized

Failed engines/gearboxes/final drives will be warranted utilizing the following options
at IMWA's discretion:

- replacement with new engine/gearbox/final drive
- replacement with factory refurbished engine/gearbox/final drive
- repair utilizing new parts or parts assemblies

Factory refurbished engines/gearboxes/final drives are guaranteed to be refurbished to manufacturer's specifications.

2. If engine/gearbox/final drive is not defective but inoperable or less than optimal due to lack of easily diagnosed misalignments and/or normal adjustments or is severely out of adjustment from poor work or understanding, the warranty claim will be denied and the Dealer will be charged for all shipping and adjustments at \$35.00 IMWA Inc. hourly rate.

Notes:

- Dealer must notify IMWA, Inc. in writing upon receipt of any motorcycle which may involve over 30 days of shop time including order and receipt time for parts, service time and delivery time. If Dealer fails to notify IMWA, Inc. in such a case, Dealer will be solely responsible for any forced motorcycle repurchase that occurs and may be subject to termination of IMWA, Inc. Dealership.
- IMWA, Inc. reserves the right to perform warranty work at its expense on any motorcycle. Dealer agrees to properly package and promptly ship any defective item that IMWA, Inc. requests to be returned.
- Do Not Ship Batteries, Seals, Gaskets or Oils to IMWA, Inc. Dispose of them according to local laws. Any questions about returning warranty items, contact IMWA, Inc.
- Defective and failed parts that were replaced by warranty are to be held at the Dealership for 90 days.
- Dealer must send failed parts and/or parts assemblies for an inspection to IMWA, Inc. within 3 (three) business days upon IMWA's request at IMWA, Inc. shipping expense.
- Dealer must provide digital pictures of failed parts and/or parts assemblies immediately upon IMWA's request.

Warranty Shipping

All warranty parts are shipped by UPS Ground or Priority Mail (USPS) paid by IMWA, Inc. If Dealer elects to upgrade to faster shipping service, Dealer agrees to pay full cost of shipping, which will be billed to Dealer's account.

DISTRIBUTOR'S LIMITED WARRANTY - NOISE CONTROL SYSTEMS

Warranty Time Period

Duration

Time or mileage, whichever occurs first

Time: twelve (12) months

Mileage: 6,000 kilometers (3,728 miles)

Coverage Begins

- the date the vehicle is delivered to the first retail purchaser, or
- the date the vehicle is first placed in service as a demonstrator, lease or company vehicle prior to the first retail sale.

Warranty

This warranty applies to factory installed noise systems on URAL motorcycles manufactured on or after May 20, 2003.

Irbit Motorworks of America warrants to the first retail purchaser and each subsequent purchaser that the motorcycle

- was designed, built and equipped to conform at the time of first retail purchase, with all US EPA noise emission standards.
- when properly maintained and used, will meet applicable noise emission regulations within the stated mileage and time periods.

The obligation of Irbit Motorworks of America

To repair or replace, at its option, any part of the exhaust system, or exhaust system's components, which are proven to be defective in material or factory workmanship under normal use for the applicable period.

Parts and Labor

No charge for replacement of defective parts.

Your obligation

To have required maintenance works performed in accordance with this manual and Service Coupons. Failure to have required maintenance performed may result in losing warranty coverage.

Note: The following items are not covered by the Noise Control System Warranty

- Failures which arise as a result of misuse, alterations or accident.
- Replacing, removing or modifying any portion of the Noise Control System (with parts not certified to be noise legal for street use)
- loss of time, inconvenience, loss of motorcycle use or other consequential damages.
- any motorcycle on which the odometer reading has been changed so that the actual usage cannot be determined.

RECOMMENDATIONS FOR REQUIRED MAINTENANCE

IT IS RECOMMENDED THAT ANY NOISE SYSTEM MAINTENANCE BE PERFORMED BY AN AUTHORIZED URAL DEALER USING GENUINE URAL REPLACEMENT PARTS. THE MAINTENANCE, REPLACEMENT OR REPAIR OF THE NOISE CONTROL SYSTEM MAY BE PERFORMED BY ANY OTHER QUALIFIED SERVICE OUTLET OR INDIVIDUAL. NON-GENUINE PARTS MAY BE USED ONLY IF SUCH PARTS ARE CERTIFIED TO COMPLY WITH US ENVIRONMENTAL PROTECTION AGENCY STANDARDS.

DISTRIBUTOR'S LIMITED WARRANTY EMISSION CONTROL SYSTEMS (49 - State)

Warranty Time Period

Duration

Time or mileage based on engine displacement - whichever occurs first.

Time: five (5) years

Mileage - for motorcycles with engine displacement of 745 cc, 30,000 km (18,642 miles)

Coverage Begins:

- the date the motorcycle is delivered to the first retail purchaser, or
- the date the motorcycle is first placed in service as a demonstrator, rental, lease or company motorcycle prior to retail sale.

Warranty Coverage

This warranty applies to new Ural motorcycles.

This warranty is given in addition to the Distributor's Limited Warranty and is the only express emission control system warranty applicable to Ural motorcycles.

Irbit Motorworks of America warrants to the first retail purchaser and each subsequent purchaser that

- the motorcycle is designed, built and equipped to conform, at the time of sale, with all US EPA emission standards applicable at the time of manufacture.
- the motorcycle, when properly maintained and used, will meet applicable emission regulations within the time and mileage periods.

The obligation of Irbit Motorworks of America

To repair or replace, at its option, any part or parts of the emission control systems which are proven to be defective in material or factory workmanship under normal use for the applicable period.

Parts & Labor

No charge to you.

Your obligation

To have required maintenance performed in accordance with the Service Coupons contained in this manual. Failure to have required maintenance performed may result in losing coverage under this warranty.

The following items are not covered by the emission control system warranty:

1. Failures which arise as a result of misuse, alterations, accident or nonperformance of maintenance as specified in the Owner's Manual and the Service Coupons.
2. The replacement of parts (such as spark plugs, fuel and oil filters, etc.) used in required maintenance.
3. Loss of time, inconvenience, loss of motorcycle use or other consequential damages.
4. Any motorcycle on which the odometer mileage has been changed so that the mileage cannot be determined.

RECOMMENDATIONS FOR REQUIRED MAINTENANCE

IT IS RECOMMENDED THAT ANY EMISSION SYSTEM MAINTENANCE BE PERFORMED BY AN

AUTHORIZED URAL DEALER USING GENUINE URAL REPLACEMENT PARTS. THE MAINTENANCE, REPLACEMENT OR REPAIR OF THE EMISSION CONTROL SYSTEM MAY BE PERFORMED BY ANY OTHER QUALIFIED SERVICE OUTLET OR INDIVIDUAL. NON-GENUINE PARTS MAY BE USED ONLY IF SUCH PARTS ARE CERTIFIED TO COMPLY WITH US ENVIRONMENTAL PROTECTION AGENCY STANDARDS.

EPA Noise Regulations

EPA noise regulations require that the following statements be included in this Owner's Manual:

TAMPERING WITH NOISE CONTROL SYSTEM PROHIBITED: Federal law prohibits the following acts or the causing thereof: (1) The removal or rendering inoperative by any person other than for purposes of maintenance, repair or replacement of any device or element of design incorporated into any new vehicle for the purpose of noise control prior to its sale or delivery to the ultimate purchaser or while it is in use or (2) the use of the vehicle after such device or element of design has been removed or rendered inoperative by any person.

AMONG THOSE ACTS PRESUMED TO CONSTITUTE TAMPERING ARE THE ACTS LISTED BELOW:

1. Replacing the muffler (s) and/or the entire exhaust system with parts not certified to be noise legal for street use.
2. Removing or modifying the muffler internal baffles in any way.
3. Replacing the air intake/cleaner assembly with one not certified to be noise legal for street use.
4. Modifying the air intake/cleaner assembly in such a way as to make the vehicle no longer noise legal for street use.

IMPORTANT: If you move from your present address or sell your motorcycle, please fill out and mail the form at the back of this manual.

REPORTING SAFETY DEFECTS

If you believe that your vehicle has a defect which could cause an accident or could cause injury or death, you should immediately inform the National Highway Traffic Safety Administration (NHTSA) in addition to notifying Irbit Motorworks of America.

If NHTSA receives similar complaints, it may open an investigation, and if it finds that a safety defect exists in a group of vehicles, it may order a recall and remedy campaign. For this reason it is very important for you to notify Irbit Motorworks of America of any change of address or ownership. There is a form in the back of this manual. NHTSA cannot become involved in individual problems between you, your dealer or Irbit Motorworks of America.

To contact NHTSA, you may either call the Auto Safety Hotline toll-free at 1-800-424-9393 (or (202) 366-0123 in Washington, DC area) or write to: NHTSA, US Department of Transportation, Washington, DC 20590.

Appendix A

Warranty Claim Form Irbit Motorworks of America, Inc.

Dealer _____ Authorized # _____ Date /__/__/__/

Motorcycle Information

VIN # /__/__/__/__/__/__/__/__/__/__/__/__/__/__/__/

Engine /__/__/__/__/__/__ Gearbox /__/__/__/__/__/__ Model _____ Mileage (km) _____

Owner's Name _____ Date of Registration /__/__/__/

Complete _____

Address _____

Comments _____

Service Information

Technician _____ Start Date /__/__/__/ Completion Date /__/__/__/

Diagnosis of Defect _____

Part #	Description	Qty	Dir. Cost

Parts Total \$ _____

All warranty parts are shipped using standard UPS ground only.

Flat Rate Schedule: Check the items that pertain to this claim.

1. Engine	2. Gearbox	3. Final Drive	4. Front Fork	5. Wheel & Tire
1.1 ___ 1.4hr	2.1 ___ 0.5hr	3.1 ___ 0.3hr	4.1 ___ 0.7hr	5.1 ___ 0.2hr
1.2 ___ 1.5hr	2.2 ___ 0.1hr	3.2 ___ 0.4hr	4.2 ___ 0.5hr	5.2 ___ 0.2hr
1.3 ___ 2.0hr	2.3 ___ 0.9hr	3.3 ___ 0.6hr	4.3 ___ 0.5hr	5.3 ___ 0.4hr
1.4 ___ 1.5hr	2.4 ___ 1.2hr	3.4 ___ 0.7hr	4.4 ___ 0.4hr	5.4 ___ 0.3hr
1.5 ___ 0.2hr	2.5 ___ 0.4hr	3.5 ___ 0.7hr		5.5 ___ 0.3hr
1.6 ___ 0.1hr		3.6 ___ 0.9hr		5.6 ___ 0.2hr
1.7 ___ 0.1hr				
1.8 ___ 0.1hr				
1.9 ___ 0.7hr				
1.10 ___ 0.4hr				
1.11 ___ 0.3hr				
1.12 ___ 0.4hr				
1.13 ___ 0.3hr				
6. Sidecar	7. Chassis	8. Electrical		
6.1 ___ 0.3hr	7.1 ___ 0.3hr	8.1 ___ 0.6hr	8.5 ___ 0.2hr	8.9 ___ 0.3hr
6.2 ___ 0.1hr	7.2 ___ 0.5hr	8.2 ___ 0.4hr	8.6 ___ 0.3hr	8.10 ___ 0.1hr
6.3 ___ 0.3hr	7.3 ___ 0.4hr	8.3 ___ 1.2hr	8.7 ___ 0.2hr	8.11 ___ 0.2hr
6.4 ___ 0.4hr	7.4 ___ 0.3hr	8.4 ___ 0.6hr	8.8 ___ 0.1hr	

Labor Information

Flat Rate Hours _____ Shop Rate \$ _____ Total \$ _____

Dealer Signature _____ Date _____

Appendix B

Flat Rate Schedule For warranty repair work on Ural motorcycles

Code	Unit or part	Job description	Allowed Time (in Hrs) for IMWA Authorized Dealers
1.0	Engine		
1.1		Engine removal/mount with gear box	1.4
1.2		Engine disassembly	1.5
1.3		Engine assembly	2.0
1.4		Engine running-in	1.5
1.5		Cylinder head removal/mount	0.2
1.6		Cylinder removal/mount	0.1
1.7		Piston rings removal/mount (1 piston)	0.1
1.8		Piston removal/mount	0.1
1.9		Camshaft removal/mount	0.7
1.10		Exhaust system disconnection/connection to cylinder heads	0.4
1.11		Valve gap adjustment (2 cylinders)	0.3
1.12		Clutch disassembly/assembly (engine removed)	0.4
1.13		Air filter assembly removal/mount	0.3
2.0	Gear box		
2.1		Gear box removal/mount (rear wheel and final drive removed)	0.5
2.2		Gear box removal/mount (engine removed)	0.1
2.3		Gear box disassembly	0.9
2.4		Gear box assembly	1.2
2.5		Gear box adjustment	0.4
3.0	Final drive		
3.1		Final drive removal/mount (rear wheel removed)	0.3
3.2		Sidecar drive removal/mount (Two-wheel drive mc)	0.4
3.3		Final drive disassembly	0.6
3.4		Final drive disassembly (Two-wheel drive mc)	0.7
3.5		Final drive assembly	0.7
3.6		Final drive assembly (Two-wheel drive mc)	0.9

Code	Unit or part	Job description	Allowed Time (in Hrs) for IMWA Authorized Dealers
3.7		Final drive seal (7205039) replacement	0.3
3.8		Drive shaft removal/mount (final drive removed)	0.2
4.0	Front Fork		
4.1		Front fork removal/mount	0.7
4.2		Front fork assy disassembly (total)	0.5
4.3		Front fork assembly (total)	0.5
4.4		Front fork bearings adjustment	0.4
5.0	Wheel & Tire		
5.1		Front wheel removal/mount	0.2
5.2		Rear wheel removal/mount	0.2
5.3		Wheel alignment and balancing	0.4
5.4		Wheel bearing adjustment	0.3
5.5		Tire removal/mount on the rim	0.3
5.6		Brake adjustment (per wheel)	0.2
6.0	Sidecar		
6.1		Sidecar removal/mount	0.3
6.2		Sidecar wheel removal/mount	0.1
6.3		Sidecar body removal/mount	0.3
6.4		Sidecar fender removal/mount	0.4
6.5		Shock absorber removal/mount	0.2
6.6		Swing arm removal/mount	0.2
6.7		Rubber member removal/mount	0.4
7.0	Chassis Parts		
7.1		Front wheel fender removal/mount	0.3
7.2		Rear wheel fender removal/mount	0.5
7.3		Gas tank removal/mount	0.4
7.4		Knee grips, molding removal/mount	0.3

Code	Unit or part	Job description	Allowed Time (in Hrs) for IMWA Authorized Dealers
7.5		Sidecar wind shield assy removal/mount	0.2
7.6		Shock absorber removal/mount	0.2
7.7		Swing arm removal/ mount	0.4
7.8		Seat removal/mount	0.2
8.0	Electrical		
8.1		Wiring diagnosis for short circuit	0.6
8.2		Battery removal/mount	0.4
8.3		Wire harness removal/mount (motorcycle)	1.2
8.4		Wire harness removal/mount (sidecar)	0.6
8.5		Alternator removal/mount	0.2
8.6		Ignition system removal/mount	0.3
8.7		Ignition coil removal/mount	0.2
8.8		Horn removal/mount	0.1
8.9		Ignition lock removal/mount	0.3
8.10		Main switch (RH or LH) removal/mount	0.1
8.11		Any lighting device removal/mount	0.2

Chapter 14

SERVICE COUPONS

IMPORTANT

Long and trouble-free enjoyment of your URAL motorcycle depends on following the recommendations outlined throughout the manual and summarized in Chapter 3, together with regular and proper servicing according to the service coupons provided on the following pages.

Dependable performance may be anticipated if your motorcycle is entrusted for maintenance to an Authorized IMWA URAL Dealer. A current list of Authorized IMWA URAL dealers may be obtained from our web site www.imz-ural.com or by sending a self-addressed stamped envelope to:

Irbit Motorworks of America
15411 NE 95th ST.
Redmond, WA 98052

Authorized IMWA URAL Dealers carry spare parts, have special tools for disassembling the motorcycle and employ experienced specialists to service and repair this motorcycle. Make it a practice to have your motorcycle serviced regularly at the mileage indicated on the Service Coupons.

An owner who is qualified and capable of doing his or her own service work is allowed to do so, without voiding the manufacturer's warranty, PROVIDED that you sign the Service Coupon and date it after the work has been performed.

WARNING: *FOR YOUR PERSONAL WELFARE, ALL THE LISTED SERVICE AND MAINTENANCE RECOMMENDATIONS IN THIS MANUAL SHOULD BE FOLLOWED BECAUSE THEY MAY AFFECT THE SAFE OPERATION OF YOUR MOTORCYCLE.*

Note: The performance of new motorcycle initial service is required to keep your new motorcycle warranty in force and to ensure proper emissions system operation.

WARNING: *STOP THE ENGINE AND SUPPORT THE MOTORCYCLE SECURELY BEFORE PERFORMING ALL SERVICE PROCEDURES. SERVICE SHOULD BE PERFORMED IN AN ADEQUATELY LIGHTED AND VENTILATED WORK AREA USING THE PROPER TOOLS. WHEN WORKING ON THE MOTORCYCLE, DO NOT SUPPORT MOTORCYCLE BY PLACING SUPPORTS UNDER BRAKE PEDAL. DAMAGE TO THE BRAKE SYSTEM COULD OCCUR CAUSING POSSIBLE MALFUNCTION AND PERSONAL INJURY.*

SERVICE COUPON NO 1. 500 KM
(To be performed between 400 to 600 km)

Date _____

Odometer reading _____ km

1. Change engine oil and filter.
2. Change transmission oil.
3. Change final drive oil.
4. Check condition of the gasoline petcock, remove any contaminants, replace in-line fuel filters.
5. Check carburetors while idling for synchronous operation.
6. Check tension of wheel spokes.
7. Check fasteners for proper tightening.
8. Check steering column bearings.
9. Check alternator bolts
10. Check brake fluid reservoirs

The maintenance above has been performed as described.

Owner's Signature

Service Technician's Signature

SERVICE COUPON NO 2. 2,500 KM
(To be performed between 2,400 to 2,600 km)

Date

Odometer reading km

1. Change engine oil and filter. (*See Lubrication List, chapter 11*)
2. Check final drive oil level.
3. Inspect air filter element.
4. Check fasteners for proper tightening.
5. Check steering column bearings.
6. Check all wheels for correct bearing adjustment.
7. Check brake fluid reservoirs.

The maintenance above has been performed as described.

Owner's Signature

Service Technician's Signature

SERVICE COUPON NO. 3. 5,000 KM
(To be performed between 4,900 to 5,100 km)

Date _____

Odometer reading _____ km.

1. Change engine oil and filter. *(See Lubrication List, chapter 11)*
2. Check transmission oil level.
3. Check final drive oil level.
4. Inspect air filter element.
5. Check condition of the gasoline petcock, remove any contaminants, replace in-line fuel filters
6. Check carburetors while idling for synchronous operation.
7. Check :
 - A Adjustment of steering column bearings.
 - B Tension of wheel spokes
8. Lubricate:
 - A Lever pins, thimbles of clutch cable
 - B Hinges of the foot brake pedal shaft and linkage.
9. Check condition and action of brakes.
10. Check tires for tread depth greater than 3/32"
11. Check fasteners for proper tightening.
12. Check brake fluid reservoirs.

The maintenance above has been performed as described.

Owner's Signature

Service Technician's Signature

SERVICE COUPON NO. 4. 7,500 KM
(To be performed between 7,400 to 7,600 km)

Date _____

Odometer reading _____ km.

1. Change engine oil. *(See Lubrication List, chapter 11)*
2. Check final drive oil level.
3. Inspect air filter element.
4. Check fasteners for proper tightening.
5. Check steering column bearings.
6. Check adjustment of wheel bearings.
7. Check brake fluid reservoirs.

The maintenance above has been performed as described.

Owner's Signature

Service Technician's Signature

SERVICE COUPON NO. 5. 10,000 KM
(To be performed between 9,900 to 10,100 km)

Date _____

Odometer reading _____ km.

1. Change engine oil and filter. *(See Lubrication List, chapter 11)*
2. Change transmission oil. *(See Lubrication List, chapter 11)*
3. Change final drive oil. *(See Lubrication List, chapter 11)*
4. Inspect air filter element.
5. Torque cylinder head stud nuts.
6. Adjust valve tappet clearance.
7. Change oil in front fork shock absorbers (on telescopic fork models)
8. Replace the spark plugs and inspect ignition leads.
9. Replace in-line fuel filters.
10. Check:
 - A Carburetors while idling for synchronous operation
 - B Check steering column bearings & adjust if required.
 - C The condition and action of the brakes, lubricate the brake shoe fulcrum pins and cams.
 - D The tension of wheel spokes. Adjust if necessary.
 - E Electric wiring. Tighten connections if required.
 - F Fasteners for proper tightening.
11. Re-pack the grease in wheel bearings, adjust the bearings.
12. Lubricate:
 - A Foot brake pedal shaft
 - B Hinges of foot brake pedal shaft and linkage.
 - C Lever pins and thimbles of clutch control cable.
 - D Drive shaft splines
13. Check battery electrolyte level.
14. Check tires, tread depth greater than 3/32"
14. Check the timing.
15. Check brake fluid reservoirs.

The maintenance above has been performed as described.

Owner's Signature

Service Technician's Signature

SERVICE COUPON NO. 6. 12,500 KM
(To be performed between 12,400 to 12,600 km)

Date _____

Odometer reading _____ km

1. Change engine oil. *(See Lubrication List, chapter 11)*
2. Check final drive oil level.
3. Inspect air filter element.
4. Check fasteners for proper tightening.
5. Check adjustment of wheel bearings.

The maintenance above has been performed as described.

Owner's Signature

Service Technician's Signature

SERVICE COUPON NO. 7 15,000 KM
(To be performed between 14,900 to 15,100 km)

Date _____

Odometer reading _____ km

1. Change engine oil and filter. *(See lubrication, chapter 11)*
2. Change transmission oil. *(See lubrication, chapter 11)*
3. Inspect air filter element
4. Check carburetors while idling for synchronous operation.
5. Check adjustment of steering column bearings.
6. Lubricate:
 - A Lever pins
 - B Hinges of the foot brake pedal shaft and linkage
7. Check condition and action of brakes
8. Check adjustment of wheel bearings.
9. Check tires for tread depth greater than 3/32".
10. Check fasteners for proper tightening.
11. Check brake fluid reservoirs.

The maintenance above has been performed as described.

Owner's Signature

Service Technician's Signature

SERVICE COUPON NO. 8. 17,500 KM
(To be carried out within 17,400 to 17,600 km)

Date _____

Odometer reading _____ km

1. Clean the air filter, .
2. Change oil in the engine and transmission. (*See Lubrication List, chapter 11*)
3. Check condition of the gasoline petcock, remove any contaminants, clean and blow out.
4. Check carburetors while idling for synchronous operation.
5. Check final drive gear oil level. (*See Lubrication List, chapter 11*)
6. Lubricate foot brake pedal shaft.
7. Check fasteners for proper tightening.
8. Adjust steering column bearings.
9. Check battery electrolyte level and fluid level.
10. Check air gap in electronic ignition between pickup and rotor (0.010 in).

The maintenance above has been performed as described.

Owner's Signature

Service Technician's Signature

SERVICE COUPON NO. 9. 20,000 KM
(To be performed between 19,900 to 20,100 km)

Date _____

Odometer reading _____ km.

1. Change engine oil and filter. *(See Lubrication List, chapter 11)*
2. Change transmission oil. *(See Lubrication List, chapter 11)*
3. Change final drive oil. *(See Lubrication List, chapter 11)*
4. Inspect air filter element.
5. Torque cylinder head stud nuts.
6. Adjust valve tappet clearance.
7. Change oil in front fork shock absorbers (on telescopic fork models)
8. Replace the spark plugs and inspect ignition leads.
9. Replace in-line fuel filters.
10. Check:
 - A Carburetors while idling for synchronous operation
 - B Check steering column bearings & adjust if required.
 - C The condition and action of the brakes.
 - D The tension of wheel spokes. Adjust if necessary.
 - E Electric wiring. Tighten connections if required.
 - F Fasteners for proper tightening.
11. Repack the grease in wheel bearings, adjust the bearings.
12. Lubricate:
 - A Foot brake pedal shaft
 - B Hinges of foot brake pedal shaft and linkage.
 - C Lever pins and thimbles of clutch and front wheel brake control cables.
 - D Drive shaft splines
13. Check battery electrolyte level.
14. Check tires, tread depth greater than 3/32"
15. Check the timing.
16. Check brake fluid reservoirs.

The maintenance above has been performed as described.

Owner's Signature

Service Technician's Signature

SERVICE COUPON NO. 10. 22,500 KM
(To be performed between 22,400 to 22,600 km)

Date _____

Odometer reading _____ km

1. Change engine oil. (*See Lubrication List, chapter 11*)
2. Check final drive oil level.
3. Inspect air filter element.
4. Check fasteners for proper tightening.
5. Check steering column bearings.
6. Check adjustment of wheel bearings.

The maintenance above has been performed as described.

Owner's Signature

Service Technician's Signature

SERVICE COUPON NO. 11. 25,000 KM
(To be performed between 24,900 to 25,100 km)

Date _____

Odometer reading _____ km.

1. Change engine oil and filter. (*See Lubrication List, chapter 11*)
2. Change transmission oil. (*See Lubrication List, chapter 11*)
3. Inspect air filter element.
4. Check carburetors while idling for synchronous operation.
5. Check:
 - A Adjustment of steering column bearings.
 - B Tension of wheel spokes
6. Lubricate:
 - A Lever pins
 - B Foot brake pedal shaft
 - C Hinges of the foot brake pedal shaft and linkage.
7. Check condition and action of brakes
8. Check tires for tread depth greater than 3/32"
9. Check fasteners for proper tightening.
10. Check brake fluid reservoirs.

The maintenance above has been performed as described.

Owner's Signature

Service Technician's Signature

SERVICE COUPON NO 12. 27,500 KM
(To be performed between 27,400 to 27,600 km)

Date _____

Odometer reading _____ km

1. Change engine oil. *(See Lubrication List, chapter 11)*
2. Check final drive oil *level*.
3. Inspect air filter element.
4. Check fasteners for proper tightening.
5. Check steering column bearings.
6. Check adjustment of wheel bearings.

The maintenance above has been performed as described.

Owner's Signature

Service Technician's Signature

SERVICE COUPON NO. 13. 30,000 KM
(To be performed between 29,900 to 30,100 km)

Date _____

Odometer reading _____ km.

1. Change engine oil and filter. *(See Lubrication List, chapter 11)*
2. Change transmission oil. *(See Lubrication List, chapter 11)*
3. Change final drive oil. *(See Lubrication List, chapter 11)*
4. Inspect air filter element.
5. Torque cylinder head stud nuts.
6. Adjust valve tappet clearance.
7. Change oil in front fork shock absorbers (on telescopic fork models)
8. Replace the spark plugs and inspect ignition leads.
9. Replace in-line fuel filters.
10. Check:
 - A Carburetors while idling for synchronous operation
 - B Check steering column bearings & adjust if required.
 - C The condition and action of the brakes, lubricate the brake shoe fulcrum pins and cams.
 - D The tension of wheel spokes. Adjust if necessary.
 - E Electric wiring. Tighten connections if required.
 - F Fasteners for proper tightening.
11. Repack the grease in wheel bearings, adjust the bearings.
12. Lubricate:
 - A Foot brake pedal shaft
 - B Hinges of foot brake pedal shaft and linkage.
 - C Lever pins and thimbles of clutch and front wheel brake control cables.
 - D Drive shaft splines
13. Check battery electrolyte level.
14. Check tires, tread depth greater than 3/32"
15. Check the timing.
16. Check brake fluid reservoirs.

The maintenance above has been performed as described.

Owner's Signature

Service Technician's Signature

NEW ADDRESS FORM

If you move, please fill out this form and mail to the address below. This will insure that you continue to receive all correspondence from Irbid Motorworks of America.

VEHICLE IDENTIFICATION NUMBER _____

OWNER'S NAME _____

OLD ADDRESS _____ APT. NO. _____

CITY _____ STATE _____ ZIP CODE _____

MY NEW ADDRESS IS:

NEW ADDRESS _____ APT. NO. _____

CITY _____ STATE _____ ZIP CODE _____

Send this form to:

**Irbid Motorworks of America,
15411 NE 95th ST.
Redmond, WA 98052
or fax to:
(425) 696 - 0834**

NEW OWNER FORM

If you purchase a Ural Motorcycle from somebody other than a dealer, please fill out this form and mail to the address below. This will insure that you receive all correspondence from Irbit Motorworks of America

VEHICLE IDENTIFICATION NUMBER

--	--	--	--	--	--	--	--	--	--	--	--	--	--	--	--	--	--	--	--

NEW OWNER'S NAME _____

ADDRESS _____ APT. NO. _____

CITY _____ STATE _____ ZIP CODE _____

DATE OF SALE _____

MO / DAY / YEAR

Purchased From _____

City _____ State _____ Zip Code _____

Send this form to:

Irbit Motorworks of America,

15411 NE 95th ST.

Redmond, WA 98052

or fax to:

(425) 696 - 0834

URAL - STARTING & RUNNING TIPS

Starting the Engine

1. Open carburetor enrichers on both carburetors (pull lever out) if temperature is below 50 degrees.
2. Make sure fuel petcock is open “**ON**” or on reserve “**RES.**” Fuel petcock handle should be in 6 or 12 o'clock position.
3. Ignition “**RUN,**” “**KILL,**” switch set to “**RUN**” (down), gearbox in “**NEUTRAL,**” master battery switch (under seat) “**ON.**”
4. Push starter button until engine fires, **OR...**
5. With foot on kick-starter lever, push foot down **swiftly and hard** open the throttle grip *slightly*. Repeat until engine fires (usually 2 or 3 kicks). Turn **OFF** enrichers.
6. Let the engine warm up for 1-3 minutes, depending on the temperature.
7. After the engine has warmed up, operate the motorcycle under moderate loads and speeds for several miles until the oil has circulated well and the engine and gearbox are functioning smoothly.

TroubleShooting

If engine does not start with above method, the problem(s) may be one or more of the following:

1. Engine is “flooded,” i.e.; the spark plugs have been “fouled” by too much throttle (and fuel) and will not spark.
Correction: Flooding is corrected by removing the spark plugs and drying them.
2. Too little fuel is getting to the engine due to low fuel in tank and/or plugged fuel lines or fuel petcock.
Correction: Clogged fuel lines or filter are corrected by blowing through fuel lines from carburetor end to remove any debris from lines. Fuel petcock filter can be cleaned by removing and cleaning.
3. Little or no spark is available to the engine due to a low battery, (dim headlight), or loose ignition wires.
Correction: Dead battery is corrected by charging battery, loose or broken ignition wires are corrected by replacing broken wire(s) or by reconnecting wires at either the spark plug cap, the ignition module, or at the ignition coil under the front cover of the engine.
- *4. **Not enough compression in the cylinders due to excessive wear or incorrect adjustment of valve(s).**
* item 4 above requires the attention of a qualified mechanic at your URAL dealer.

Pre-Trip Check List

1. Check all lights and the horn for proper operation.
2. Check the brake and clutch levers and/or pedals.
3. Make sure all wheels and the final drive assemblies are securely fastened .
4. Check the carburetor flanges and air filter ducts for integrity and proper alignment.
5. Check the tire tread depth - should be greater than 1/8 inch.
6. Check the sidecar attachment mounts – all mounts should be securely tightened.

Gasoline level in the fully filled tank should be 10 - 15 mm / ½ - ¾ in. below the lower edge of the tank filler. Do not overfill the tank.

See that the oil level in the engine crankcase is not higher than the top and not lower than the bottom marks on the dipstick with the filler plug undone. (See chapter 4 Lubrication System)

Here Are Some Helpful Publications To Help You With Your New Ural

Learning to Ride The Ural With Sidecar Accessory
Available through the Whitehorse Press
www.whitehorsepress.com

Available through Mike Weaver
threeweavers@earthlink.net
www.molotovmotors.com

Weav's Useful Information and Technical Guide to Antique Russian Motorcycles and Sidecars